

# ANSCHLÄGE

Siehe auch:  
Lagerblöcke und  
Anschläge



Zylindrischer  
Anschlag

Progressiver konischer  
Anschlag

Progressiver Anschlag  
LEVAFLEX

EVIDGOM-Anschlag

## BESCHREIBUNG

Es sind mehrere Anschlag-Ausführungen lieferbar :

- Zylindrische Anschläge (DIABOLOS).
- Progressive konische Anschläge.
- Progressive LEVAFLEX-Anschläge mit mittiger Aussparung.
- EVIDGOM-Anschläge.

## FUNKTIONSWEISE

Aufgrund ihrer Konzeption haben die elastischen Anschläge von PAULSTRA folgende Grundeigenschaften:

- Hohe Verformbarkeit und dadurch hohe Energieaufnahme
- Progressive Kennlinie dank entsprechend ausgelegter Form des Gummi.

### Vorteile:

- Elastische Anschläge von PAULSTRA sind geräuschärmer als starre Anschläge. Außerdem mindern sie den Verschleiß der gelagerten Maschinen.

### Empfehlung:

- Die Montage ist so vorzunehmen, daß die Achse des Anschlags beim Aufprall senkrecht zur Aufprallfläche steht.
- Im Augenblick des Aufpralls vergrößert sich der Außendurchmesser des Anschlags. Der dafür notwendige Platz ist bei der Montage zu berücksichtigen.

# EINBAUMASSE UND TECHNISCHE EIGENSCHAFTEN

## ZYLINDRISCHE ANSCHLÄGE

Abb. 1



Abb. 2



### Neue RADIAFLEX Typen

Ø A mm	B mm	C	G mm	Fig.	H mm	Höchstlast daN	Einfederung mm	Energie in Joule	Bestell-Nr.
12,5	10	M5	10	1	-	12	2	0,12	511110
	13,5					2,5	0,13	511128	
	15					3	0,16	511115	
	20					3,5	0,14	511125	
	20					8			
16	10	M4	-	2	2,5	20	2	0,20	511150
	15					3	0,30	511151	
	10					2	0,20	511152	
	15					3	0,30	511153	
	20					2	0,20	511292	
16	10	M5	12	1	-	20	2	0,20	511294
	15					3	0,30	511294	
	20					4	0,30	511296	
	25					5	0,30	511296	
	25					5	0,30	511298	
20	15	M6	-	2	4	35	4	0,70	511154
	8,5					1,5	0,30	511200	
	15					4	0,70	511215	
	20					5	0,70	511220	
	25					5,5	0,80	511225	
25,5	10	M6	18	1	-	80	2	0,80	511158
	15					3,5	1,00	511155	
	20					5	1,20	511159	
	30					8	2,00	511160	
	15					4	1,00	511164	
25,5	20	-	-	2	4	55	5,5	1,20	511162
	20					4	1,20	511162	
	30					8	2,00	511163	
	20					4	1,20	511162	
	30					8	2,00	511163	

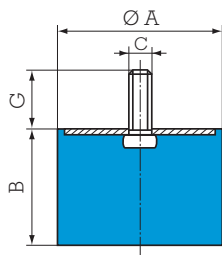
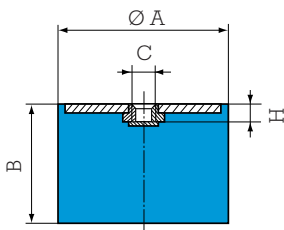
Ø A mm	B mm	C	G mm	Abb.	H mm	Höchstlast daN	Einfederung mm	Energie in Joule	Bestell-Nr.					
25,5	10	M8	20	1	-	80	2	0,80	511265					
	15					3,5	1,00	511270						
	19					4,5	1,20	511251						
	22					5,5	1,30	511275						
	25					6	1,50	511280						
	30					8	2,00	511285						
	40					10	2,50	511290						
	22					M8	-	2	6	80	6	2,40	511156	
	30					15	M8	25	1	-	90	3,5	1,50	511308
						22					6	2,40	511310	
30		8	2,80	511312										
40		9	2,70	511314										
40	30	M8	20	1	-	120	7	4,60	511157					
	40					10	6,00	511161						
	20	M10	25	1	-	160	5	4,00	511450					
	25					6	4,50	511401						
	35					8	4,80	511452						
	40					10	6,00	511454						
45	11					6,60	511456							
25	M10					25	1	-	300	6	9,00	511525		
35		9	11,20	511535										
45		11	10,00	511545										
60	25	M10	25	1	-	400	6	12,00	511625					
	36					9	13,50	511635						
	45					11	13,70	511645						
	25					M10	25	1	-	450	9	20,00	511735	
35	12	21,00	511750											
70	14	21,00	511770											
80	25	M14	35	1	-	1100	6	33,00	513801					
	30					8	38,00	511830						
	40					10	30,00	511840						
	70					17	42,50	511870						
	80					19	43,00	511880						

## PROGRESSIVE KONISCHE ANSCHLÄGE

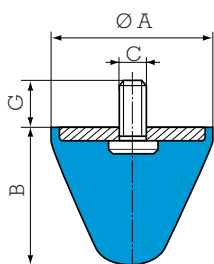

Bestell-Nr.	Ø A mm	B mm	C	G mm	Wiederholte Stöße			Einzelne Stöße Energie in Joule	Gewicht g
					Energie in Joules	Einfederung mm	Reaktion daN		
512251	25,5	19	M8	20	3	8	100	9	20
512307	30	30	M8	25	6	15	140	18	37
512301	30	30	M6	13,5	6	15	140	18	30
512515	50	50	M10	25	30	25	340	90	85
512501	50	50	M8	20	30	25	340	90	75
512516	50	64	M10	25	40	32	370	120	150
512502	50	64	M8	35	40	32	370	120	150
512517	50	58	M10	25	37	28	400	110	130
512503	50	58	M8	15	37	28	400	110	120
512608	60	40	M10	25	27	18	550	70	140
512601	60	40	M14	62	27	18	550	70	200
512700	72	58	M10	25	50	26	550	150	290
512721	72	58	M12	30	50	26	550	150	300
512951	95	80	M16	45	120	37	1100	350	750

## DIABOLO-ANSCHLÄGE

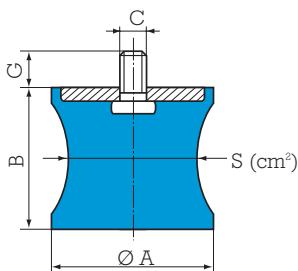

Bestell-Nr.	S cm²	Ø A mm	B mm	C	G mm	Dynamische Höchstlast daN	Einfederung mm	Statische Höchstlast daN	Durchbiegung mm	Energie in Joules	Gewicht g
511571	5	57	42	M8	20	100	10	40	4	1	60
511572	9,5	57	42	M8	20	200	12	75	5,5	2	80
511601	19,5	60	57	M10	25	350	15	150	8	6	190
511801	38,5	80	65	M14	30	800	16	300	9,5	15	500
511951	50	95	70	M16	35	1000	18	400	9,5	20	790

## PROGRESSIVE LEVAFLEX-ANSCHLÄGE

Bestell-Nr.	A mm	B mm	Ø C mm	D mm	Ø E mm	Ø G mm	H mm	Gewicht g
514085	85	85	8,5	69	8,5	20	5	600
514110	110	110	12,5	90	8,5	30	6	1200
514130	130	130	19	106	11	40	6	2000
514160	160	160	23	132	11	45	8	3000
514200	200	200	28	168	13	60	10	7000

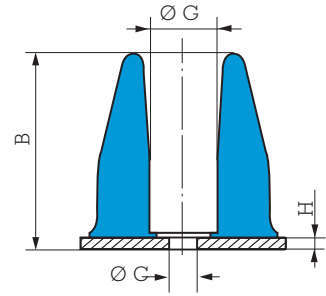

Wiederholte Stöße			Einzelne Stöße Energie in Joule	Bestell-Nr. (versch. Härten)
Energie in Joule	Einfederung mm	Reaktion daN		
170	40	1200	500	514085/60
280	40	1700	850	514085/75
330	50	1800	1000	514110/60
550	50	3400	1500	514110/75
600	65	2800	1800	514130/60
650	60	3000	1900	514130/75
1050	75	4500	3000	514160/60
1200	90	4000	3600	514200/60
1300	70	6000	3900	514160/75
2200	85	7800	6600	514200/75

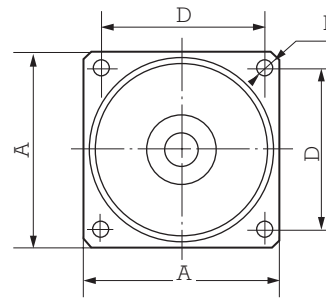

## EVIDGOM-ANSCHLÄGE

Wiederholte Stöße			Einzelne Stöße Energie in Joule	Bestell-Nr. (versch. Härten)
Energie in Joule	Einfederung mm	Reaktion daN		
31	30	190	95	810644
100	50	580	300	810645
110	45	600	330	810666
180	67	750	540	810642
350	75	1250	1050	810653
360	65	1400	1100	810655
400	85	1500	1200	810669
300	70	900	--	810784
600	75	1625	--	810775
1050	90	2375	--	810776
2500	90	5500	--	810733/60
7100	150	11000	--	810732/60
9500	200	9500	--	810731/60
13000	130	18000	--	810732/75
17500	175	19000	--	810731/75
21000	200	25000	--	810735/60
29000	250	35000	--	810734/60
41000	200	70000	--	810735/75
50000	250	55000	--	810734/75



Abb. 1

Abb. 2

Bestell-Nr. Anschlag	Abb.	Bestell-Nr. EVIDGOM in Ganzkautschukausführung	Ø A mm	B mm	C	Ø C <sub>1</sub> mm	Ø C <sub>2</sub> mm	Ø D mm	Ø A unter Last mm
810642	1	810022	85	120	M16	20	30		114
810644	1	810004	55	55	M10	14	14		72
810645	2	810035	66	93	M16	20	14		100
810653	1	810023	100	130	M16	20	30		140
810655	1	810025	110	132	M16	20	30		142
810666	2	810046	76	90	M16	20	14		98
810669	2	810029	110	150	M16	20	30		155
810731	3	--	250	400	6 X M24	70	70	150	360
810732	3	--	250	315	6 X M24	70	70	150	380
810733	3	--	250	230	6 X M24	70	70	150	370
810734	3	--	350	500	8 X M24	85	85	196	445
810735	3	--	350	395	8 X M24	85	85	196	500
810775	1	810015	155	150	M16	25	40		202
810776	1	810016	188	180	M24	40	30		256
810784	1	810014	125	140	M16	30	25		168

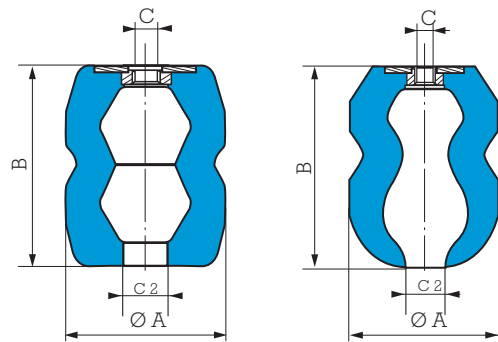

Abb. 3



ANMERKUNG: Die angegebenen Werte gelten für Versuchsbedingungen, die einer Aufprallgeschwindigkeit von 1 m/s entsprechen. Für Anwendungen, bei denen die Geschwindigkeiten wesentlich höher sind, bitten wir um Rücksprache.

# KENNLINIEN UND ENERGIEAUFNAHME DER PROGRESSIVEN ANSCHLÄGE LEVAFLEX UND EVIDGOM (Seite 57 und 58)

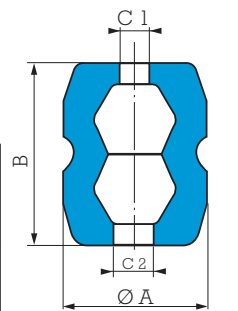
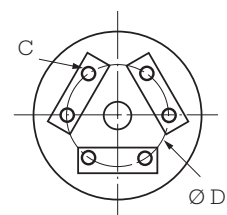
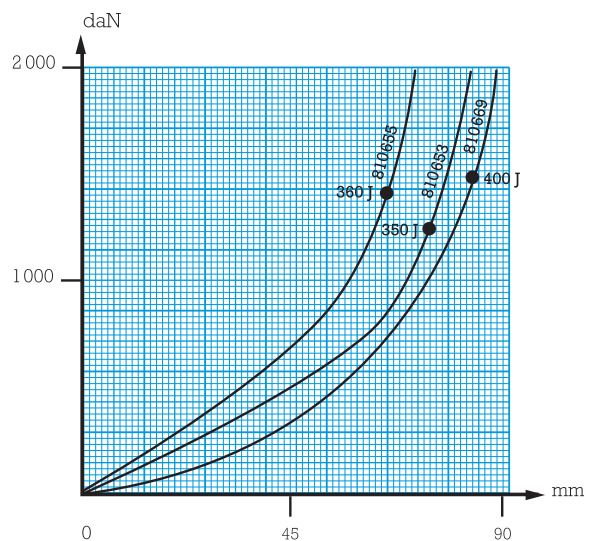
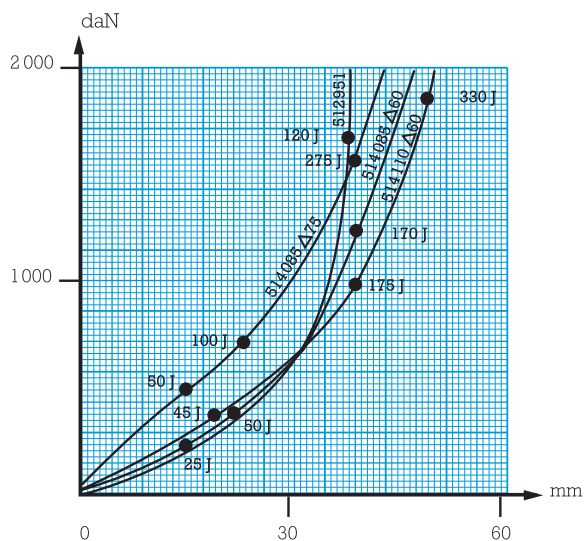
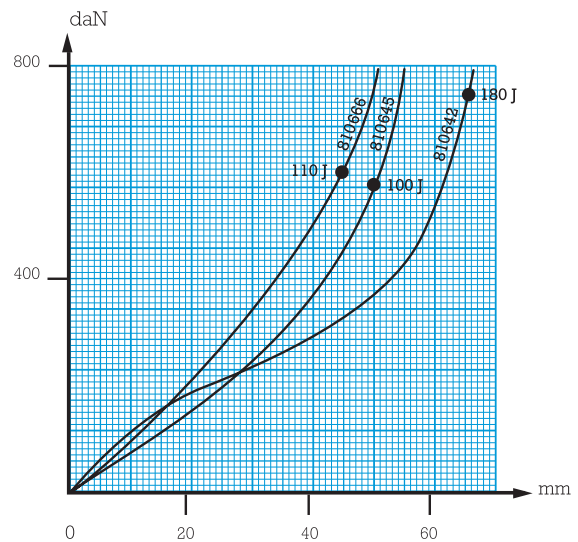
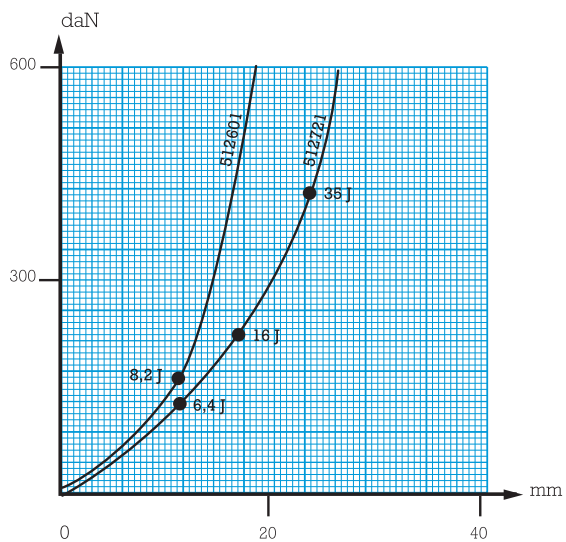
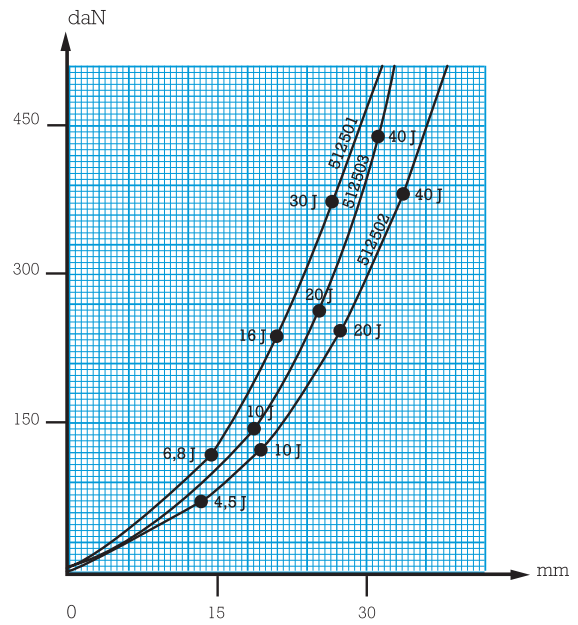
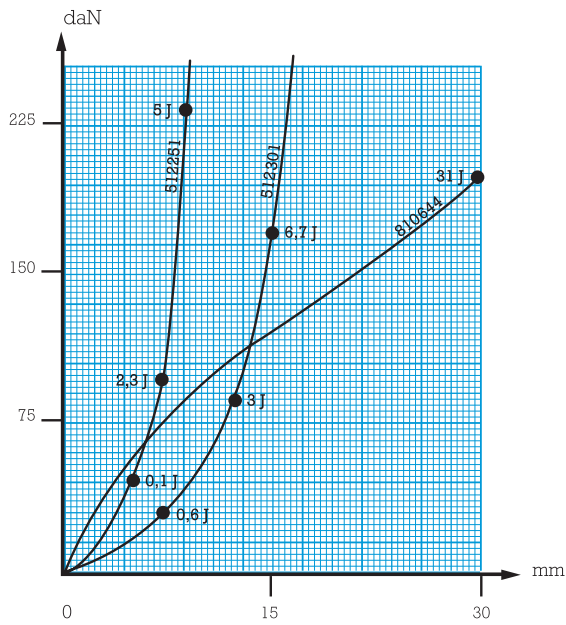

# KENNLINIEN UND ENERGIEAUFNAHME DER PROGRESSIVEN ANSCHLÄGE LEVAFLEX UND EVIDGOM

