

# FLUID COOLING | Shell & Tube EK Series

## COPPER & STEEL CONSTRUCTION

### Features

- Compact Size
- High Efficiency Finned Bundle Design
- Low Cost
- Optional Patented Built-in Surge-Cushion® Relief Bypass
- 3/16" Tube Size
- Heat Removal up to 400 Horsepower (300 kW)
- Oil Flow rates up to 80 U.S. GPM (300 Liters/min.)
- Large Oil Connections for Minimum Entering and Exiting Flow Restriction
- Removable End Bonnets for easy tube cleaning
- Mounting Brackets Designed so that Cooler can be Rotated in 90° Increments
- High Pressure Ratings
- Complete Line of Accessories Available

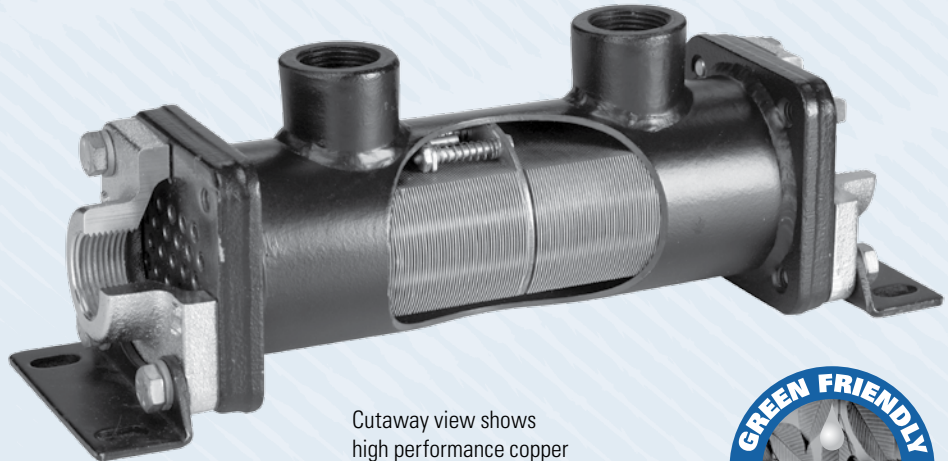

Cutaway view shows high performance copper tube/aluminum fin cooling chamber with patented SURGE-CUSHION® relief bypass valve.



### Ratings

**Maximum Pressure/Shell side** 500 psi  
**Maximum Pressure/Tubeshell side** 150 psi  
**Maximum Temperature** 250° F

### Materials

**Shell** Steel  
**Tube Sheets** Steel  
**Baffles** Steel  
**Mounting Brackets** Steel  
**Gaskets** Nitrile Rubber/Cellulose Fiber  
**Nameplate** Aluminum Foil  
**Tubes** Copper  
**Fins** Aluminum  
**End Caps** Grey Iron

### Surge-Cushion (Option)

The SURGE-CUSHION® is a protective device (patented) designed to internally bypass a portion of the oil flow during cold start conditions, or when sudden flow surges temporarily exceed the maximum flow allowed for a given cooler. This device may replace an external bypass valve, but it is not intended to bypass the total oil flow.

### Maximum Flow Rates

Unit Size	Shell Side GPM	Tube Side GPM		
		One Pass	Two Pass	Four Pass
500	20	13	6	N/A
700	60	24	12	6
1000	80	56	28	14

*Incorrect installation can cause premature failure.*

## How to Order

<b>Model Series</b> EK EKS EKM EKF EKFM	<b>Model Size Selected</b>			<b>Baffle Spacing</b> EK-1036 & EK-1048 Models Only	<b>Tube Side Passes</b> O - One Pass T - Two Pass F - Four Pass	<b>Surge Cushion</b> Blank - No Relief Bypass R - Relief Bypass	<b>Cooling Tube Material</b> Blank - Copper CN - CuNi	<b>End Bonnet Material</b> Blank - Cast Iron NP - Electroless Nickel Plate

EK = NPT Oil connections; NPT Water connections.  
 EKS = SAE O-Ring Oil connections; NPT Water connections.  
 EKM = BSPP Oil connections; BSPP Water connections.  
 EKF = SAE 4 Bolt Flange (Tapped SAE) Oil connections; NPT Water connections.  
 EKFM = SAE 4 Bolt Flange (Tapped Metric) Oil connections; BSPP Water connections.

# Dimensions

## One Pass

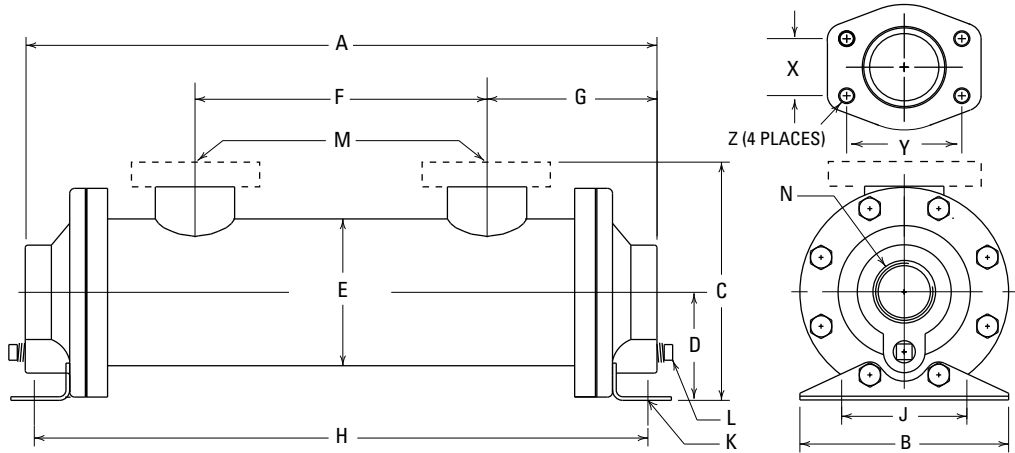

Flange Size	1-1/2		2	
	X	1.41	1.69	
Y	2.75	3.06		
EKF Z	1/2 - 13 UNC-28			
EKFM Z	M-12			

MODEL	A	B	C		D	E	F	G	H	J	K	L	M				N
			NPT / BSPP SAE O-RING	SAE FLANGE									NPT	SAE O-RING	SAE FLANGE	BSPP	
EK-505	7.38	3.5 MAX. WIDTH	3.90	N/A	1.62	2.55 DIA.	2.19	2.59	7.44	2.50	.34 x .62 SLOT	N/A	3/4	#8 3/4-16 UNF-2B	N/A	3/4	3/4
EK-508	10.38						3.85		10.44								
EK-510	12.38						5.85		12.44								
EK-512	14.38						7.85		14.44								
EK-514	16.38						9.85		16.44								
EK-518	20.38						13.85		20.44								
EK-524	26.38						19.85		26.44								
EK-536	38.38						31.85		38.44								
EK-708	11.12	5.0 MAX. WIDTH	5.47	5.71	2.59	3.52 DIA.	3.00	4.07	10.71	3.00	.44 x .75 SLOT	1 1/2	#24 1 7/8-12 UN-2B	1 1/2	1 1/2	1 1/4	
EK-712	15.12						7.00		14.71								
EK-714	17.12						9.00		16.71								
EK-718	21.12						13.00		20.71								
EK-724	27.12						19.00		26.71								
EK-736	39.12						31.00		38.71								
EK-1012	15.33	6.5 MAX. WIDTH	7.64	8.28	4.00	5.05 DIA.	6.18	4.57	15.45	4.00	.44 x 1.00 SLOT	2	2	2	1 1/2		
EK-1014	17.33						8.18		17.45								
EK-1018	21.33						12.18		21.45								
EK-1024	27.33						18.18		27.45								
EK-1036	39.33						30.18		39.45								
EK-1048	51.33						42.18		51.45								

NOTE: We reserve the right to make reasonable design changes without notice. All dimensions are in inches.

# Dimensions

## Two Pass

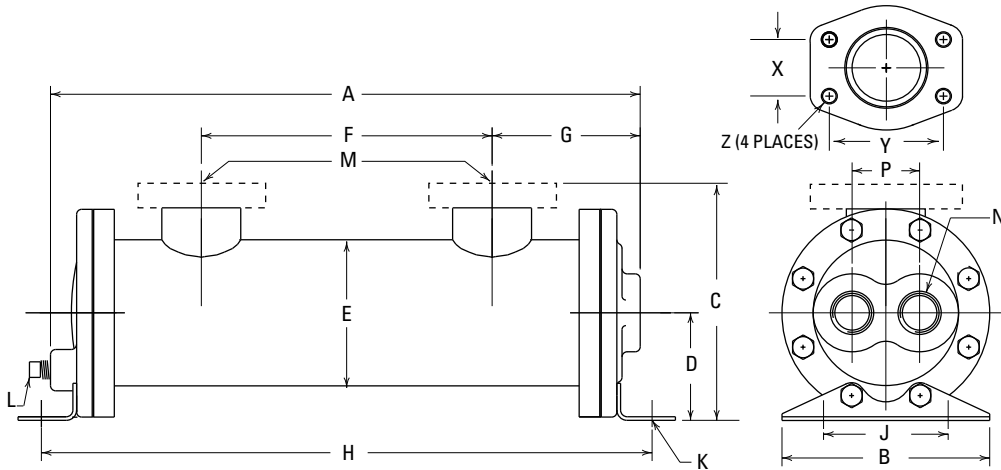

Flange Size	1-1/2	2
X	1.41	1.69
Y	2.75	3.06
EKF Z	1/2 - 13 UNC-28	
EKFM Z	M-12	

WATER COOLED EK

MODEL	A	B	C		D	E	F	G	H	J	K	L	M				N	P
			NPT / BSPP SAE O-RING	SAE FLANGE									NPT	SAE O-RING	SAE FLANGE	BSPP		
EK-505	7.38	3.5 MAX. WIDTH	3.90	N/A	1.62	2.55 DIA.	2.19	3.26	7.44	2.50	.34 x .62 SLOT	N/A	3/4	#8 3/4-16 UNF-2B	N/A	3/4	3/8	1.12
EK-508	10.38						3.85		10.44									
EK-510	12.38						5.85		12.44									
EK-512	14.38						7.85		14.44									
EK-514	16.38						9.85		16.44									
EK-518	20.38						13.85		20.44									
EK-524	26.38						19.85		26.44									
EK-536	38.38						31.85		38.44									
EK-708	10.19	5.0 MAX. WIDTH	5.47	5.71	2.59	3.52 DIA.	3.00	3.57	10.71	3.00	.44 x .75 SLOT	1/4	1 1/2	#24 17/8-12 UN-2B	1 1/2	3/4	1.62	
EK-712	14.19						7.00		14.71									
EK-714	16.19						9.00		16.71									
EK-718	20.19						13.00		20.71									
EK-724	26.19						19.00		26.71									
EK-736	39.19						31.00		38.71									
EK-1012	14.58	6.5 MAX. WIDTH	7.64	8.28	4.00	5.05 DIA.	6.18	4.45	15.45	4.00	.44 x 1.00 SLOT	2	2	2	1.0	2.38		
EK-1014	16.58						8.18		17.45									
EK-1018	20.58						12.18		21.45									
EK-1024	26.58						18.18		27.45									
EK-1036	38.58						30.18		39.45									
EK-1048	50.58						42.18		51.45									

NOTE: We reserve the right to make reasonable design changes without notice. All dimensions are in inches.

# Dimensions

## Four Pass

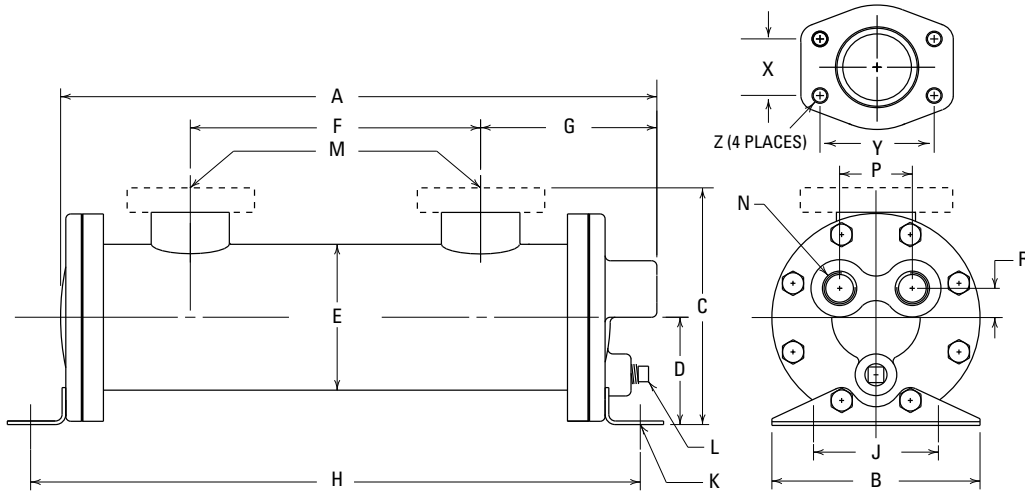

Flange Size	1-1/2	2
X	1.41	1.69
Y	2.75	3.06
EKF Z	1/2 - 13 UNC-28	
EKFM Z	M-12	

MODEL	A	B	C		D	E	F	G	H	J	K	L	M				N	P	R
			NPT / BSPP SAE O-RING	SAE FLANGE									NPT	SAE O-RING	SAE FLANGE	BSPP			
EK-708	10.37	MAX. WIDTH	5.47	5.71	2.59	3.52 DIA.	3.00	4.25	10.71	3.00	.44 x .75 SLOT	1/4	1 1/2	#24 17/8-12 UN-2B	1 1/2	1/2	1.75	.70	
EK-712	14.37						7.00		14.71										
EK-714	16.37						9.00		16.71										
EK-718	20.37						13.00		20.71										
EK-724	26.37						19.00		26.71										
EK-736	38.37						31.00		38.71										
EK-1012	14.33	MAX. WIDTH	7.64	8.28	4.00	5.05 DIA.	6.18	4.45	15.45	4.00	.44 x 1.00 SLOT	1/4	2	2	3/4	2.50	.89		
EK-1014	16.33						8.18		17.45										
EK-1018	20.33						12.18		21.45										
EK-1024	26.33						18.18		27.45										
EK-1036	38.33						30.18		39.45										
EK-1048	50.33						42.18		51.45										

NOTE: We reserve the right to make reasonable design changes without notice. All dimensions are in inches.

# Selection Procedure

Performance Curves are based on 100SSU oil leaving the cooler 40°F higher than the incoming water temperature (40°F approach temperature).

**Step 1 Determine the Heat Load.** This will vary with different systems, but typically coolers are sized to remove 25 to 50% of the input nameplate horsepower. (Example: 100 HP Power Unit x .33 = 33 HP Heat load.)

If BTU/Hr. is known:  $HP = \frac{BTU/Hr}{2545}$

**Step 2 Determine Approach Temperature.**

Desired oil leaving cooler °F – Water Inlet temp. °F = Actual Approach

**Step 3 Determine Curve Horsepower Heat Load.** Enter the information from above:

$HP \text{ heat load} \times \frac{40}{\text{Actual Approach}} \times \frac{\text{Viscosity}}{\text{Correction A}} = \text{Curve Horsepower}$

**Step 4 Enter curves** at oil flow through cooler and curve horsepower. Any curve above the intersecting point will work.

**Step 5 Determine Oil Pressure Drop from Curves.** Multiply pressure drop from curve by correction factor B found on oil viscosity correction curve.

● = 5 PSI; ■ = 10 PSI; ▲ = 20 PSI.

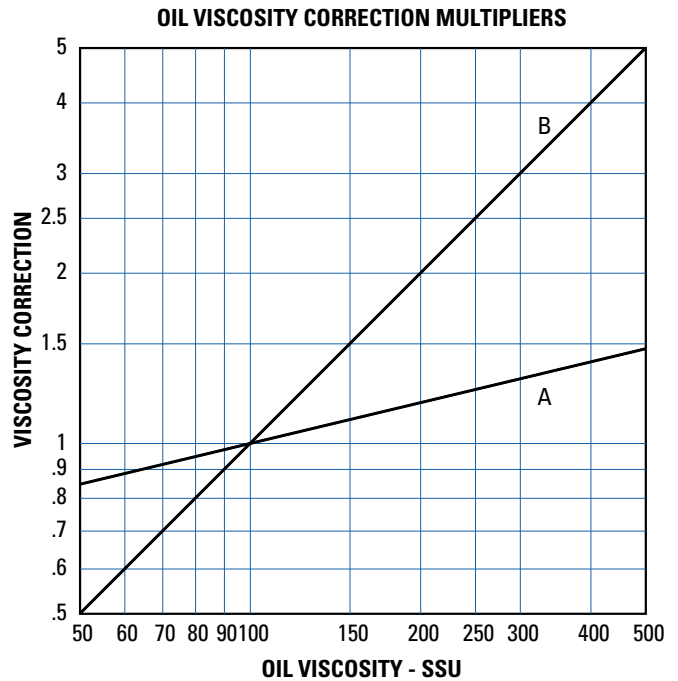

## Oil Temperature

Oil coolers can be selected by using entering or leaving oil temperatures.

Typical operating temperature ranges are:

Hydraulic Motor Oil	110°F - 130°F
Hydrostatic Drive Oil	130°F - 180°F
Lube Oil Circuits	110°F - 130°F
Automatic Transmission Fluid	200°F - 300°F

## Desired Reservoir Temperature

**Return Line Cooling:** Desired temperature is the oil temperature leaving the cooler. This will be the same temperature that will be found in the reservoir.

**Off-Line Recirculation Cooling Loop:** Desired temperature is the temperature entering the cooler. In this case, the oil temperature change must be determined so that the actual oil leaving temperature can be found. Calculate the oil temperature change (Oil  $\Delta T$ ) with this formula:

$Oil \Delta T = (BTU's/Hr.) / (GPM \text{ Oil Flow} \times 210)$

To calculate the oil leaving temperature from the cooler, use this formula:

$Oil \text{ Leaving Temperature} = Oil \text{ Entering Temperature} - Oil \Delta T$

This formula may also be used in any application where the only temperature available is the entering oil temperature.

**Oil Pressure Drop:** Most systems can tolerate a pressure drop through the heat exchanger of 20 to 30 PSI. Excessive pressure drop should be avoided. Care should be taken to limit pressure drop to 5 PSI or less for case drain applications where high back pressure may damage the pump shaft seals.

## Recirculation Loop

### Water Cooled Hydraulic Oil Coolers

#### BASIS:

- 40°F Entering temperature difference (Maintain reservoir 40°F above the incoming water temperature)
- Heat removal 30% of input horsepower
- Hydraulic system flow (GPM) x 3 = Gallons; reservoir size
- 1 GPM cooler flow per HP heat to be removed
- Turn-over reservoir 3-4 times per hour
- Maximum flows

System Horsepower	HP Heat Load	Minimum Required GPM Oil Flow	Minimum Required GPM Water Flow	Heat Exchanger Model Number
3	.9	1	1	EK-505-T
5	1.5	2		
7.5	2.25	3	1.5	EK-512-T
10	3			
15	4.5			
20	6	6	3	EK-712-T
25	7.5			
30	9	9	4.5	EK-712-T
40	12			
50	15	15	7.5	EK-1012-T
60	18			
75	22.5	23	12	EK-1012-T
100	30			

# Performance Curves

## 1:1 Oil to Water Ratio – High Water Usage

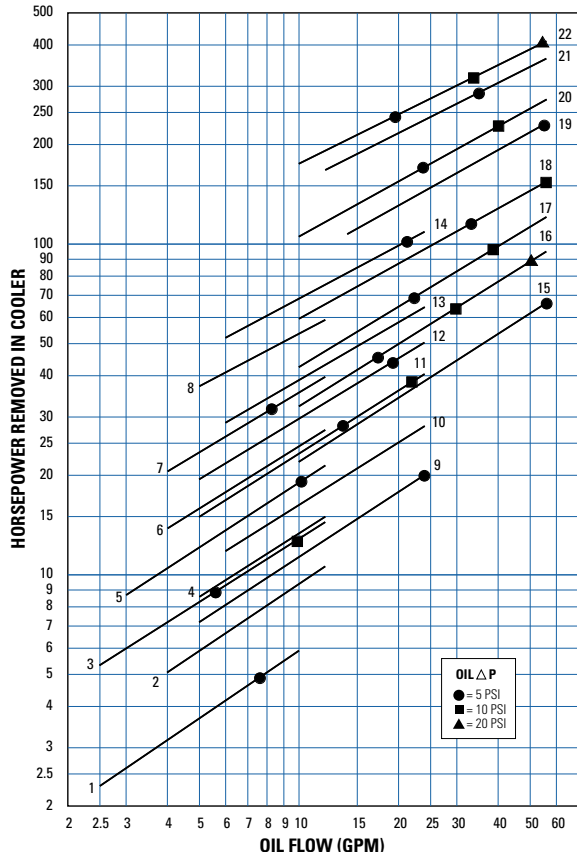

Curve Number	Model	Approx. Weights (lbs)	
		Net	Shipping
1	EK-505-0	6	7
2	EK-508-0	7	8
3	EK-510-0	8	9
4	EK-512-0	9	10
5	EK-514-0	10	11
6	EK-518-0	11	12
7	EK-524-0	13	14
8	EK-536-0	17	18
9	EK-708-0	15	16
10	EK-712-0	18	19
11	EK-714-0	19	20
12	EK-718-0	22	23
13	EK-724-0	26	28
14	EK-736-0	34	36
15	EK-1012-0	35	37
16	EK-1014-0	38	40
17	EK-1018-0	42	45
18	EK-1024-0	50	55
19	EK-1036-9-0	67	85
20	EK-1036-6-0	67	85
21	EK-1048-8-0	78	95
22	EK-1048-6-0	78	95

## 2:1 Oil to Water Ratio – Medium Water Usage

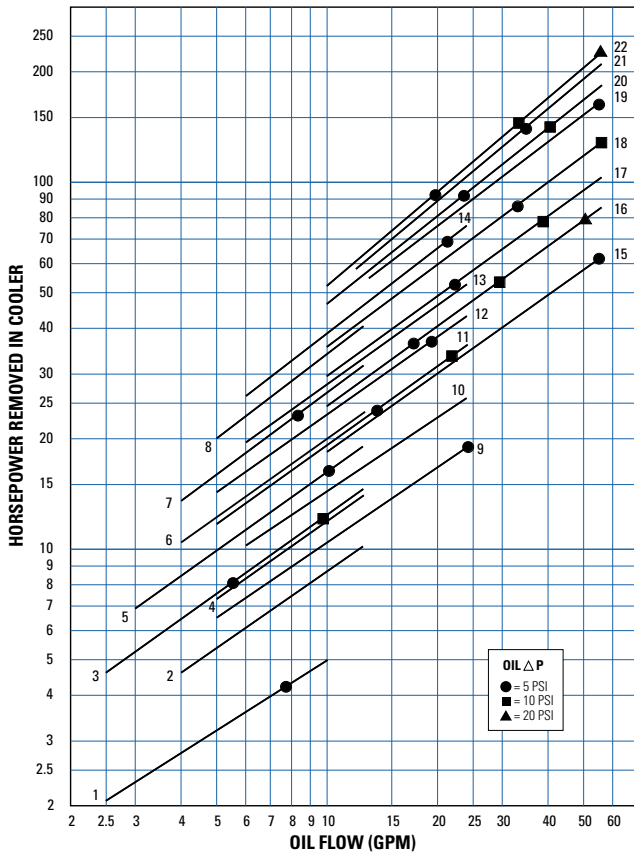

Curve Number	Model	Approx. Weights (lbs)	
		Net	Shipping
1	EK-505-T	6	7
2	EK-508-T	7	8
3	EK-510-T	8	9
4	EK-512-T	9	10
5	EK-514-T	10	11
6	EK-518-T	11	12
7	EK-524-T	13	14
8	EK-536-T	17	18
9	EK-708-T	15	16
10	EK-712-T	18	19
11	EK-714-T	19	20
12	EK-718-T	22	23
13	EK-724-T	26	28
14	EK-736-T	34	36
15	EK-1012-T	35	37
16	EK-1014-T	38	40
17	EK-1018-T	42	45
18	EK-1024-T	50	55
19	EK-1036-9-T	67	85
20	EK-1036-6-T	67	85
21	EK-1048-8-T	78	95
22	EK-1048-6-T	78	95

# Performance Curves

## 4:1 Oil to Water Ratio – Low Water Usage

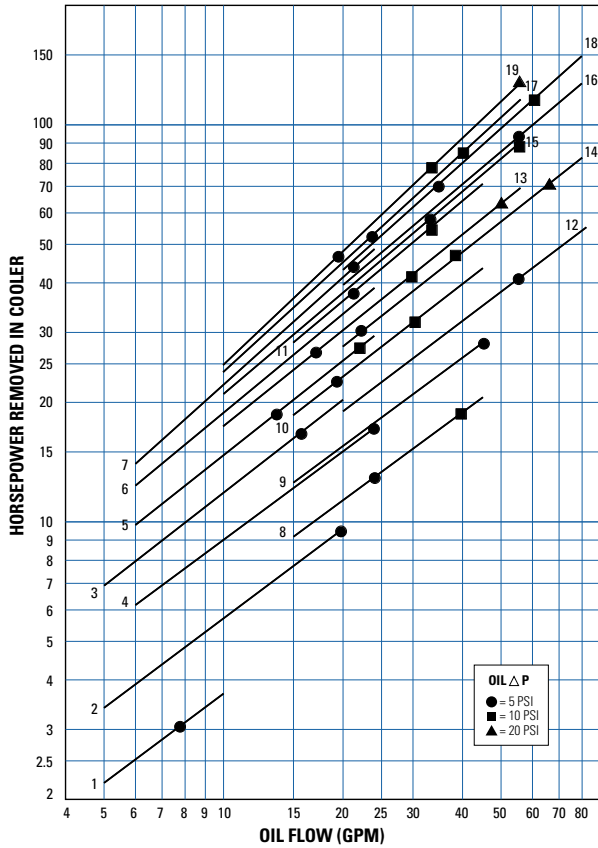

Curve Number	Model	Approx. Weights (lbs)	
		Net	Shipping
1	EK-505-T	6	7
2	EK-508-T	7	8
3	EK-518-T	11	12
4	EK-708-F	15	16
5	EK-714-F	19	20
6	EK-724-F	26	28
7	EK-736-F	34	36
8	EK-708-T	15	16
9	EK-712-T	18	19
10	EK-718-T	22	23
11	EK-736-T	34	36
12	EK-1012-T	35	37
13	EK-1014-T	38	40
14	EK-1018-T	42	45
15	EK-1024-T	50	55
16	EK-1036-9-T	67	85
17	EK-1036-6-T	67	85
18	EK-1048-8-T	78	95
19	EK-1048-6-T	78	95

## 7:1 Oil to Water Ratio – Lower Water Usage

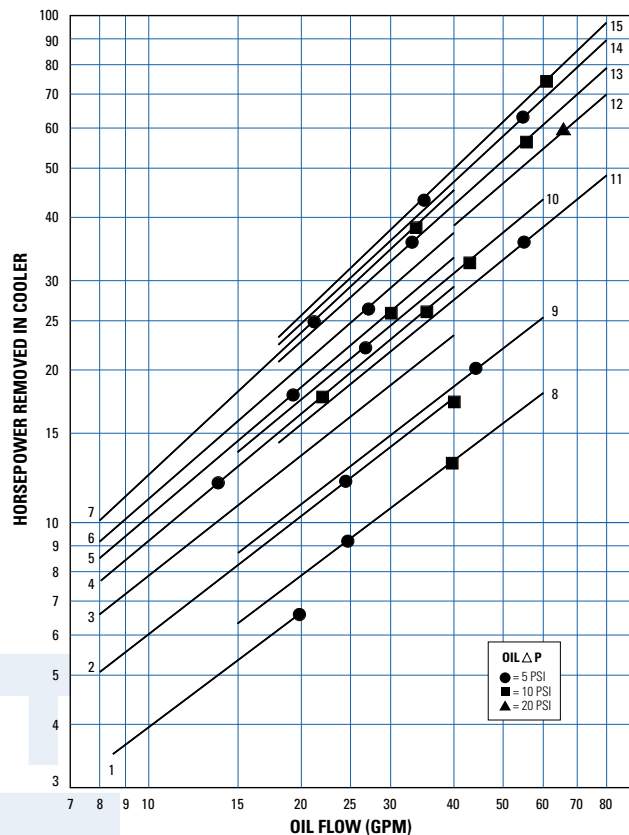

Curve Number	Model	Approx. Weights (lbs)	
		Net	Shipping
1	EK-508-T	7	8
2	EK-708-F	15	16
3	EK-712-F	18	19
4	EK-714-F	19	20
5	EK-718-F	22	23
6	EK-124-F	26	28
7	EK-736-F	34	36
8	EK-708-T	15	16
9	EK-712-T	18	19
10	EK-724-T	26	28
11	EK-1012-T	35	37
12	EK-1018-T	42	45
13	EK-1024-T	50	55
14	EK-1036-9-T	67	85
15	EK-1048-8-T	78	95

# Performance Curves

## 10:1 Oil to Water Ratio – Lowest Water Usage

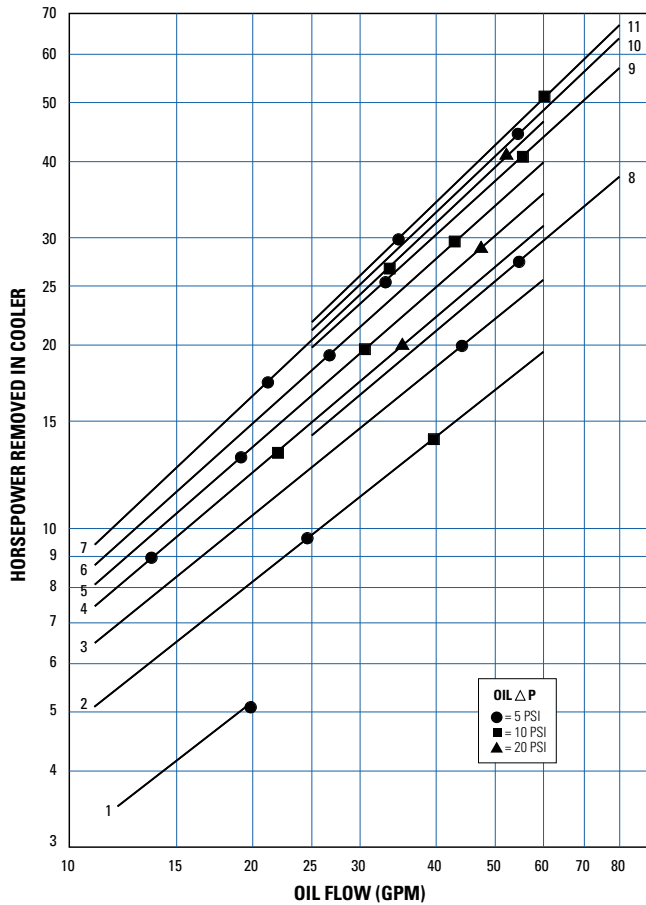

Curve Number	Model	Approx. Weights (lbs)	
		Net	Shipping
1	EK-508-T	7	8
2	EK-708-F	15	16
3	EK-712-F	18	19
4	EK-714-F	19	20
5	EK-718-F	22	23
6	EK-724-F	26	28
7	EK-736-F	34	36
8	EK-1012-F	35	37
9	EK-1014-F	50	55
10	EK-1036-9-F	67	85
11	EK-1048-8-F	78	95

## Recirculation Loop

### Water Cooled Hydraulic Oil Coolers

#### BASIS:

- 40°F Entering temperature difference (Maintain reservoir 40°F above the incoming water temperature)
- Heat removal 30% of input horsepower
- Hydraulic system flow (GPM) x 3 = Gallons; reservoir size
- 1 GPM cooler flow per HP heat to be removed
- Turn-over reservoir 3-4 times per hour
- Maximum flows

System Horsepower	HP Heat Load	Minimum Required GPM Oil Flow	Minimum Required GPM Water Flow	Heat Exchanger Model Number
3	.9	1	1	EK-505-T
5	1.5	2		
7.5	2.25	3	1.5	EK-512-T
10	3			
15	4.5			
20	6	6	3	EK-712-T
25	7.5			
30	9	9	4.5	EK-1012-T
40	12			
50	15	15	7.5	EK-1012-T
60	18			
75	22.5	23	12	EK-1012-T
100	30			