

**SKF**



# SKF SYSTEM 24 TLSD Series

Instructions for use  
Mode d'emploi  
Bedienungsanleitung  
Instrucciones de uso  
Manuale d'istruzioni

Bruksanvisning  
Gebruiksaanwijzing  
Instruções de uso  
使用说明书  
Инструкция по эксплуатации

## Eu-declaration of conformity

We,

SKF Maintenance Products  
Kelvinbaan 16  
3439 MT Nieuwegein  
The Netherlands

herewith declare that the following product:

### SKF SYSTEM 24 Automatic Lubricator TLSD Series

has been designed and manufactured in accordance with:  
EMC DIRECTIVE 2004/108/EC as outlined in the harmonized norm for  
EN61000-6-2:2005,  
EN61000-6-3:2007 /A1:2011,  
EN61000-4-2, EN61000-4-3, EN61000-4-8

EUROPEAN ROHS DIRECTIVE 2011/65/EU

Nieuwegein, The Netherlands,  
May 2013



Sébastien David  
Manager Product Development and Quality



TMBA G11D



MP5409





[www.skf.com/lubrication](http://www.skf.com/lubrication)



LGFP 2  
LHMT 68  
LHFP 150  
LHHT 265



## Safety recommendations

### English

- At prolonged low temperatures there is a small risk that the battery pack capacity will not allow the full lubricant content to be dispensed.
- Under such operating conditions, it is recommended to exchange the battery pack when half the lubricant is dispensed.
- **Warning:** If the battery pack is exchanged then the empty canister indicator could be disabled.

### Français

- Pendant une exposition prolongée à basses températures, il se peut que la capacité des batteries ne permette pas la distribution totale du lubrifiant.
- Dans de telles conditions, il est recommandé de changer les batteries quand la moitié du lubrifiant a été distribuée.
- **Attention:** si les batteries sont remplacées, l'indicateur de réservoir vide pourrait ne plus fonctionner.

### Deutsch

- Bei anhaltenden geringen Temperaturen ist in seltenen Fällen möglich, dass die Batterien vor vollständiger Entleerung der Kartusche entladen sind.
- Ist der Füllstand um 50% gesunken, ist es unter solchen Bedingungen ratsam, die Batterien vorzeitig auszutauschen.
- **Hinweis:** Nach Austausch der Batterien könnte die Warnanzeige für die vollständige Entleerung des Schmierstoffbehälters deaktiviert werden.

### Español

- A temperaturas bajas prolongadas existe un pequeño riesgo que la capacidad del paquete de la batería no permitirá que el contenido completo del lubricante sea dispensado.
- Bajo tales condiciones de funcionamiento, se recomienda intercambiar el paquete de la batería cuando la mitad del lubricante sea dispensado.
- **Advertencia:** Si el paquete de la batería se intercambia entonces el indicador del frasco vacío podría estar desactivado.

### Italiano

- Con l'esposizione prolungata alle basse temperature sussiste un minimo rischio che la capacità del pacco batteria impedisca la completa erogazione del lubrificante.

- Qualora sussistano tali condizioni di funzionamento, si consiglia di sostituire il pacco batteria non appena il lubrificante sia stato erogato per metà.
- **Attenzione:** quando si sostituisce il pacco batteria, l'indicatore di livello del contenitore potrebbe essere disabilitato.

### Svenska

- Vid långvarig låg temperatur finns en liten risk att batteripaketets kapacitet inte räcker till att tömma hela smörjmängden i behållaren.
- Vid sådana driftförhållanden rekommenderas att byta batteripaketet efter att halva behållaren tömts.
- **Varning:** Om batteripaketet byts, kan indikator för tom behållare komma att inaktiveras.

### Nederlands

- Bij langdurige perioden met lage temperatuur is er een kleine kans dat de capaciteit van de batterij onvoldoende is om de volledige inhoud van de smeerunit te leveren.
- Het is raadzaam om onder deze omstandigheden de batterij halverwege de doseertijd te vervangen.
- **Pas op:** Bij het vervangen van de batterij kan de LED indicatie van een lege smeerunit uitgezet worden.

### Português

- Diante de temperaturas baixas por um tempo prolongado, existe um pequeno risco de que a capacidade do conjunto de baterias não permita que seja suprido o conteúdo total do lubrificante.
- Em face de tais condições operacionais, recomenda-se a substituição do conjunto de baterias quando a metade do lubrificante tiver sido distribuída.
- **Atenção:** Se o conjunto de baterias for substituído então o indicador de que o tambor está vazio pode ser desativado.

### 中文

- 在长期的低温状态下，存在着电池容量受温度影响不足以分配所有的润滑剂的可能。
- 在这种工况下，建议当润滑剂分配一半后更换电池组。
- 警告：电池组被更换后，该单点润滑器的空罐指示灯将失效。

### Русский

- При продолжительной работе при низких температурах существует небольшой риск, что ёмкость батареи не обеспечит достаточной мощности для подачи всего объёма смазочного вещества.
- При таких условиях работы рекомендуется менять батарею после того, как была израсходована половина объёма смазочного вещества.
- Предупреждение: после замены батареи можно отключить индикатор пустой ёмкости.



TLSD .../125

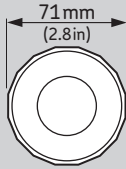

TLSD .../250

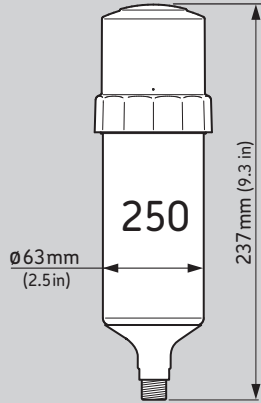
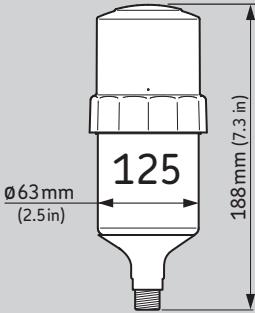

125 ml  
4.2 fl. oz.

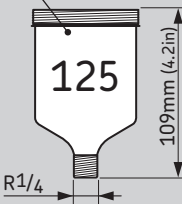

250 ml  
8.5 fl. oz.

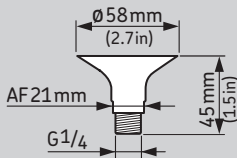
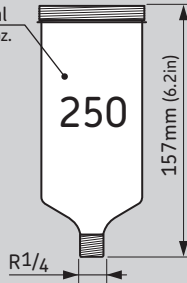



Max.  
5 bar  
(72 psi)



Max.  
3 bar  
(43 psi)



1/2/3  
4/6/8  
9/10/12  
months

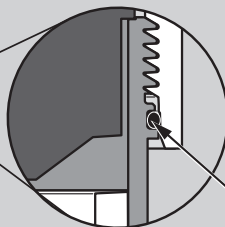

IP65



TLSD 1-BAT



EU Code:  
160604

TLSD 1-BATC



EU Code:  
160605



EU Code:  
150110



LG..



LGWA 2	TLSD 125/WA2	TLSD 250/WA2	LGWA 2/SD125	LGWA 2/SD250
LGEM 2	TLSD 125/EM2	TLSD 250/EM2	LGEM 2/SD125	LGEM 2/SD250
LGHB 2	TLSD 125/HB2	TLSD 250/HB2	LGHB 2/SD125	LGHB 2/SD250
LGHP 2	TLSD 125/HP2	TLSD 250/HP2	LGHP 2/SD125	LGHP 2/SD250
LGFP 2	TLSD 125/FP2	TLSD 250/FP2	LGFP 2/SD125	LGFP 2/SD250



LH..

LHMT 68	TLSD 125/HMT68	TLSD 250/HMT68	LHMT 68/SD125	LHMT 68/SD250
LHHT 265			LHHT 265/SD125	LHHT 265/SD250
LHFP 150	TLSD 125/HFP15	TLSD 250/HFP15	LHFP 150/SD125	LHFP 150/SD250



LG..



LGWM 2	TLSD 125C/WM2	TLSD 250C/WM2	LGWM 2/SD125C	LGWM 2/SD250C
--------	---------------	---------------	---------------	---------------

31  
months

OFF	0 ml/day	0 ml/day
1M	4,1 ml/day	8,2 ml/day
2M	2,0 ml/day	4,1 ml/day
3M	1,4 ml/day	2,7 ml/day
4M	1,0 ml/day	2,0 ml/day
6M	0,7 ml/day	1,4 ml/day
8M	0,5 ml/day	1,0 ml/day
9M	0,5 ml/day	0,9 ml/day
10M	0,4 ml/day	0,8 ml/day
12M	0,3 ml/day	0,7 ml/day



30 s

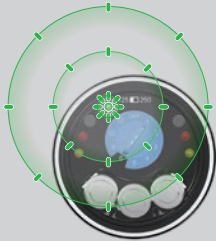

OK

2 s

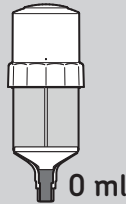
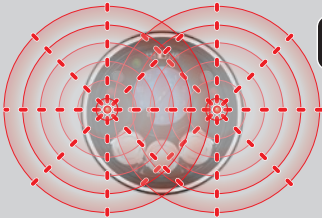

STOP

5 s

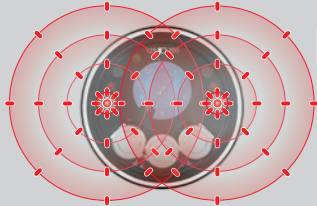

> 5 bar  
(72 psi)



ERROR  
STOP

5 s

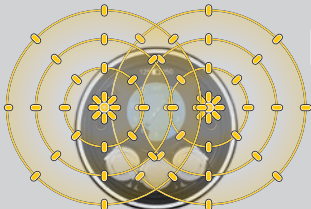



~ 5 bar  
(72 psi)

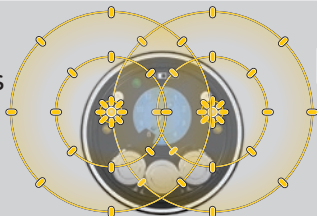

30 s



 **TLSD 1-BAT**  
0°C - 50°C  
(32°F - 122°F)

 **TLSD 1-BATC**  
-10°C - 50°C  
(14°F - 122°F)

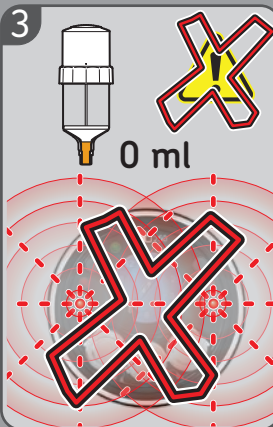
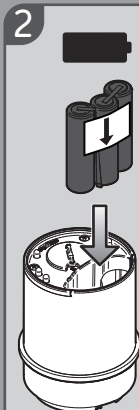
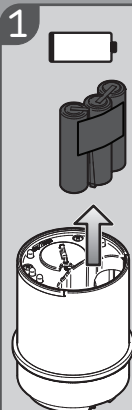
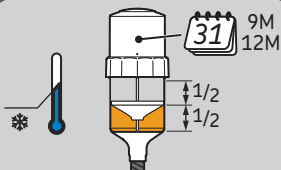
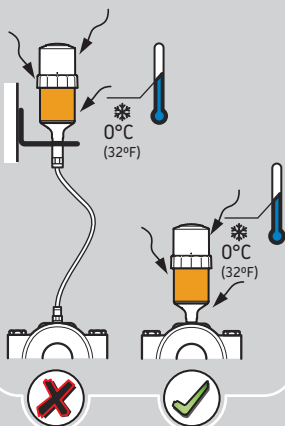

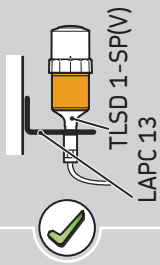
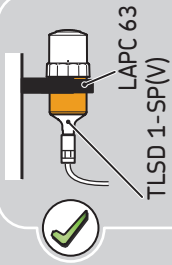
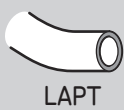
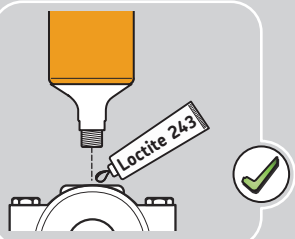
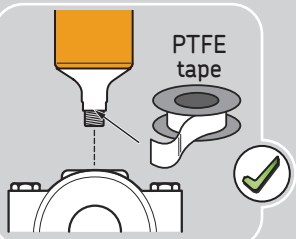
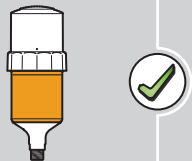
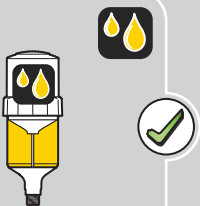

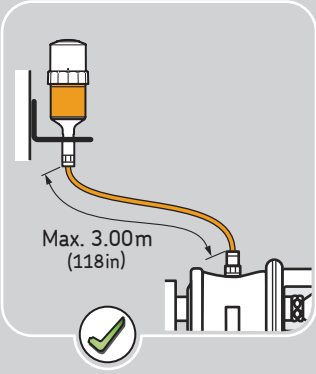
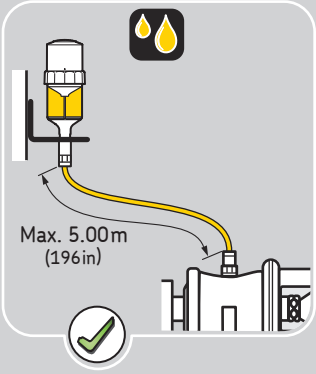
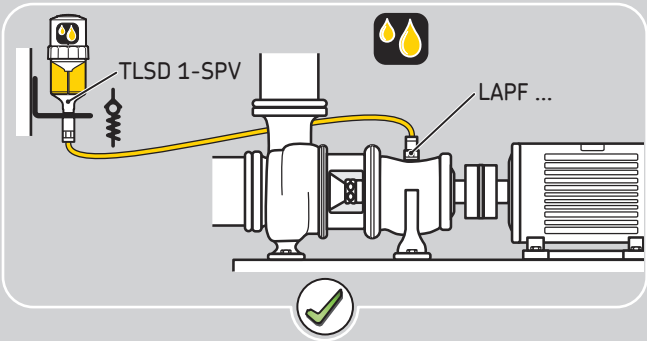
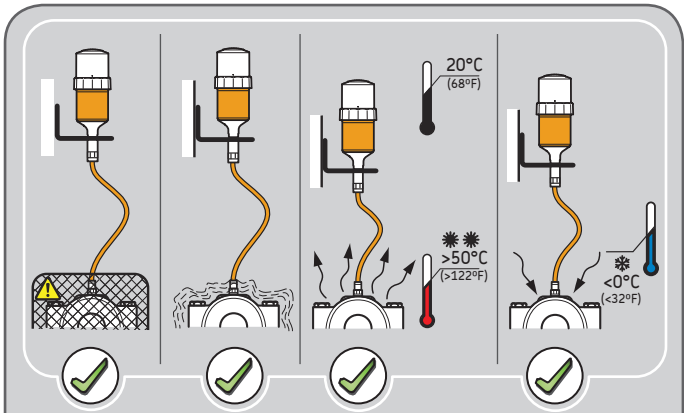

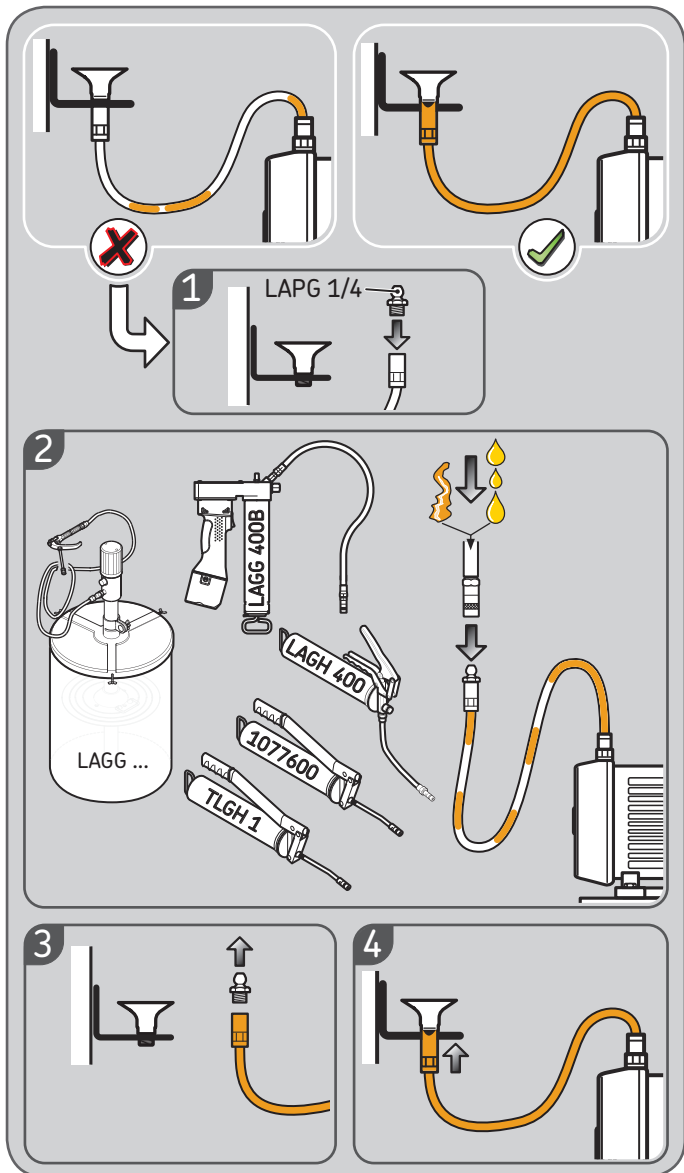

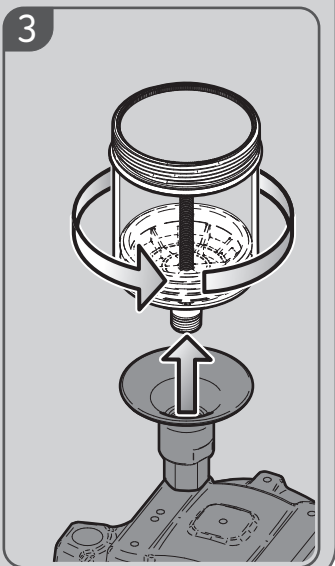
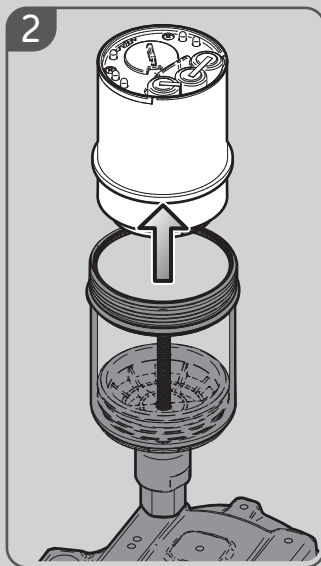
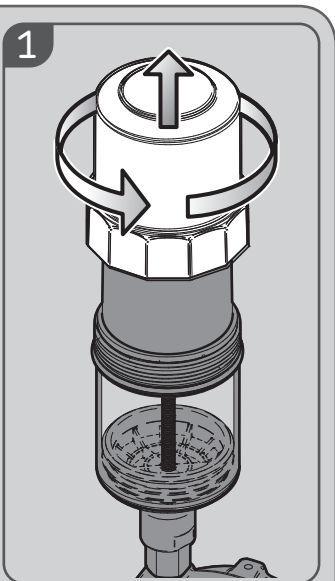
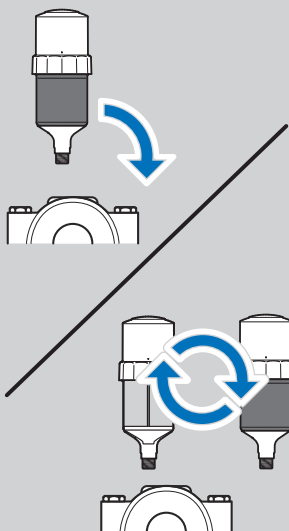

4

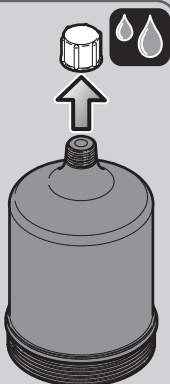
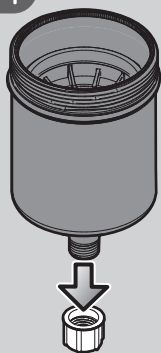

5

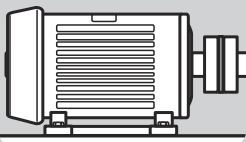
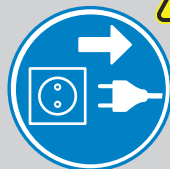

6

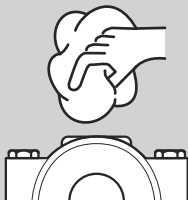
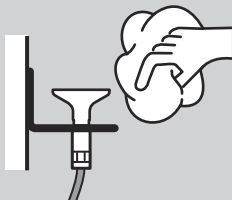

7

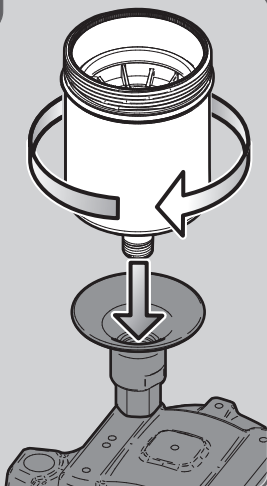

8

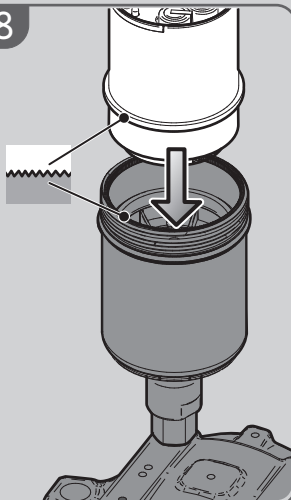

9

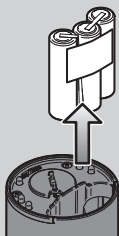

10

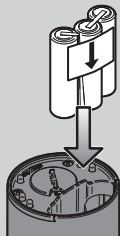

11

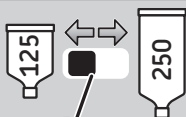

DialSet  
[skf.com/lubrication](http://skf.com/lubrication)  
[mapro.skf.com/dialset](http://mapro.skf.com/dialset)

12

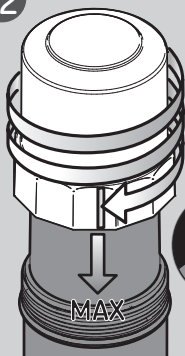

13

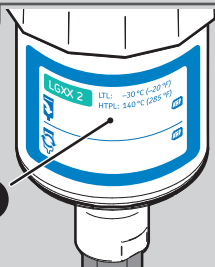

A

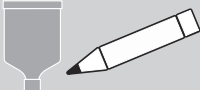

A



date

14-12-2013



wk 50 - 13





14

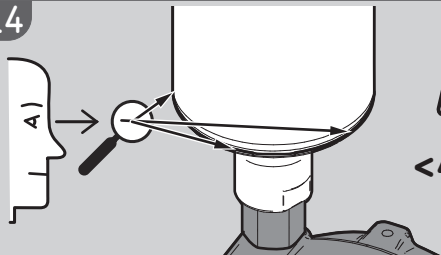

< 4 days

15

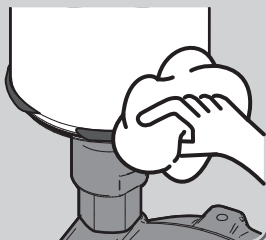
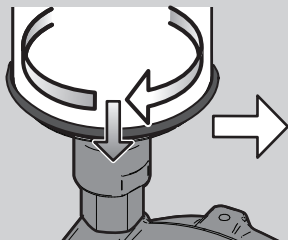

16

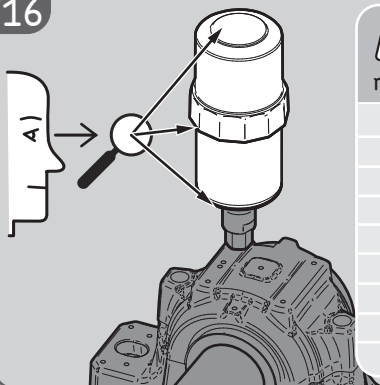

months



days

1M	> 4 x	< 7
2M	> 4 x	< 14
3M	> 4 x	< 22
4M	> 4 x	< 30
6M	> 6 x	< 30
8M	> 8 x	< 30
9M	> 9 x	< 30
10M	> 10 x	< 30
12M	> 12 x	< 30

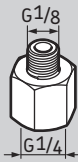
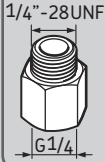
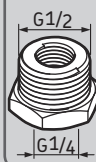
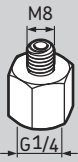
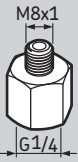
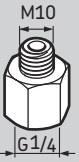
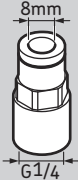
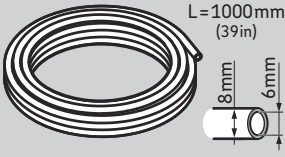
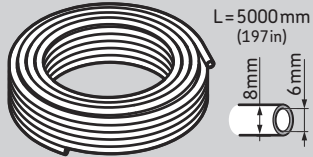
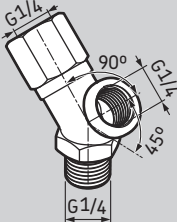
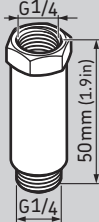
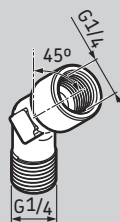
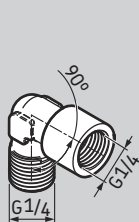
**LAPN 1/8****LAPN 1/4****LAPN 1/4UNF****LAPN 3/8****LAPN 1/2****LAPN 6****LAPN 8****LAPN 8x1****LAPN 10****LAPN 10x1****LAPN 12****LAPN 12x1.5****LAPF F1/4****LAPF M1/8****LAPF M1/4****LAPF M3/8****LAPE 35****LAPT 1000****LAPT 5000****LAPM 2****LAPE 50****LAPA 45****LAPA 90**

TLSD 1-BAT



TLSD 1-BATC



LAPG 1/4

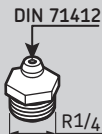

TLSD 1-SP

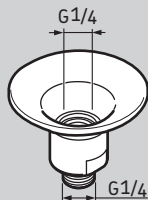

LAPC 13

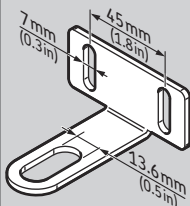

LAPC 63

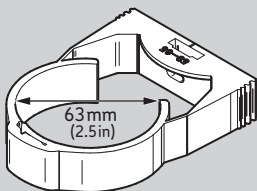

TLSD 1-SPV

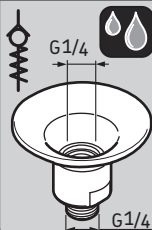

LAPV 1/4

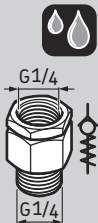

LAPV 1/8

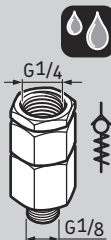

LAPB 5-16E1

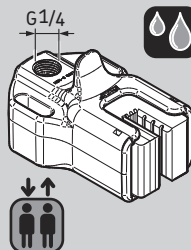

LAPB 3x4E1

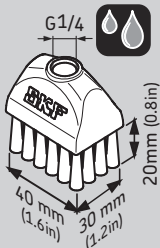

LAPB 3x7E1

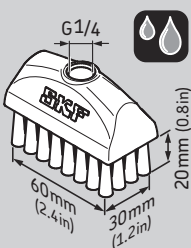

LAPB 3x10E1

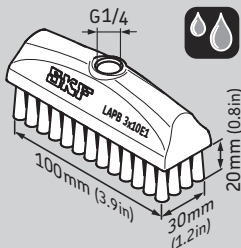

The contents of this publication are the copyright of the publisher and may not be reproduced (even extracts) unless prior written permission is granted. Every care has been taken to ensure the accuracy of the information contained in this publication but no liability can be accepted for any loss or damage whether direct, indirect or consequential arising out of the use of the information contained herein.

Le contenu de cette publication est soumis au copyright de l'éditeur et sa reproduction, même partielle, est interdite sans autorisation écrite préalable. Le plus grand soin a été apporté à l'exactitude des informations données dans cette publication mais SKF décline toute responsabilité pour les pertes ou dommages directs ou indirects découlant de l'utilisation du contenu du présent document.

Nachdruck, auch auszugsweise, nur mit unserer vorherigen schriftlichen Genehmigung gestattet. Die Angaben in dieser Druckschrift wurden mit größter Sorgfalt auf ihre Richtigkeit hin überprüft. Trotzdem kann keine Haftung für Verluste oder Schäden irgendwelcher Art übernommen werden, die sich mittelbar oder unmittelbar aus der Verwendung der hier enthaltenen Informationen ergeben.

El contenido de esta publicación es propiedad de los editores y no puede reproducirse (incluso parcialmente) sin autorización previa por escrito. Se ha tenido el máximo cuidado para garantizar la exactitud de la información contenida en esta publicación, pero no se acepta ninguna responsabilidad por pérdidas o daños, ya sean directos, indirectos o consecuentes, que se produzcan como resultado del uso de dicha información.

La riproduzione, anche parziale, del contenuto di questa pubblicazione è consentita soltanto previa autorizzazione scritta della SKF. Nella stesura è stata dedicata la massima attenzione al fine di assicurare l'accuratezza dei dati, tuttavia non si possono accettare responsabilità per eventuali errori od omissioni, nonché per danni o perdite diretti o indiretti derivanti dall'uso delle informazioni qui contenute.

Eftertryck – även i utdrag – får ske endast med SKFs skriftliga medgivande i förväg. Vissa bilder används under licens från Shutterstock.com. Uppgifterna i denna trycksak har kontrollerats med största noggrannhet, men SKF kan inte påta sig något ansvar för eventuell förlust eller skada, direkt, indirekt eller som en konsekvens av användningen av informationen i denna trycksak.

De inhoud van deze publicatie is auteursrechtelijk beschermd en mag niet worden overgenomen (zelfs niet gedeeltelijk) tenzij schriftelijke toestemming is gegeven. Elke zorgvuldigheid is genomen om de nauwkeurigheid van de informatie in deze publicatie te verzekeren maar geen aansprakelijkheid kan voor om het even welke verlies of schade worden aanvaard die direct, indirect of volgend uit het gebruik van informatie uit deze publicatie volgt.

O conteúdo desta publicação é de direito autoral do editor e não pode ser reproduzido (nem mesmo parcialmente), a não ser com permissão prévia por escrito. Todo cuidado foi tomado para assegurar a precisão das informações contidas nesta publicação, mas nenhuma responsabilidade pode ser aceita por qualquer perda ou dano, seja direto, indireto ou consequente, como resultado do uso das informações aqui contidas.

本出版物内容的著作权归出版者所有且未经事先书面许可不得被复制（甚至引用）。我们已采取了一切注意措施以确定本出版物包含的信息准确无误，但我们不对因使用此等信息而产生的任何损失或损害承担任何责任，不论此等责任是直接、间接或附随性的。

Содержание этой публикации является собственностью издателя и не может быть воспроизведено (даже частично) без предварительного письменного разрешения. Несмотря на то, что были приняты все меры по обеспечению точности информации, содержащейся в настоящем издании, издатель не несет ответственности за любой ущерб, прямой или косвенный, вытекающий из использования вышеуказанной информации.

## SKF Maintenance Products

[www.mapro.skf.com](http://www.mapro.skf.com)  
[www.skf.com/lubrication](http://www.skf.com/lubrication)

MP5409



© SKF is a registered trademark of the SKF Group.  
© SKF Group 2013/10