

Fittings and Accessories

for Centralized Lubrication Systems and General Use



This brochure provides an overview of metallic pipe unions for fluid engineering.

This brochure is divided into the sections

- Solderless pipe unions with tapered sleeve acc. to DIN 3862
- SKF Quick Connectors
- Solderless pipe unions with cutting sleeve acc. to DIN EN ISO 8434-1 and DIN 2353
- Other accessories

! **Important information on product usage**

All products from SKF may be used only for their intended purpose as described in this brochure and in any instructions. If operating instructions are supplied with the products, they must be read and followed.

Not all lubricants are suitable for use in centralized lubrication systems. SKF does offer an inspection service to test customer supplied lubricant to determine if it can be used in a centralized system. SKF lubrication systems or their components are not approved for use with gases, liquefied gases, pressurized gases in solution and fluids with a vapor pressure exceeding normal atmospheric pressure (1 013 mbar) by more than 0,5 bar at their maximum permissible temperature.

Hazardous materials of any kind, especially the materials classified as hazardous by European Community Directive EC 67/548/EEC, Article 2, Par. 2, may only be used to fill SKF centralized lubrication systems and components and delivered and/or distributed with the same after consulting with and receiving written approval from SKF.

Contents

Solderless pipe union with

tapered sleeve acc. to DIN 3862 4–18

Adaptors	6, 7
Banjo fittings	17, 18
Bracketed connectors	11
Bulkhead connectors	8
Connectors	5, 10
Counterbores	4
Cross joints	17
Distributor manifold	13–16
Double tapered sleeves	5
Elbows	8, 9
Elbow connectors	11
Flat washers	9
Form counterbores	4
Reducing adapters	7
Reinforcing sockets	5
Screw plugs	9
Socket unions	5
Tapered sleeves	5
Tee connectors	12
Threaded sockets	10
Tube-to-tube-connector	11
Vent plugs	9

SKF Quick Connectors 19–21

Adaptors	19
Banjo fittings	20
Check valve	21
Claw groove	19
Connector	21
Elbows	20, 21
Locking pin	21
Tube cutter	19

Solderless pipe union with

cutting sleeve acc. to DIN EN ISO 8434-1/ DIN 2353 22–28

Banjo fittings	24
Cone plug	28
Connectors for pressure gauges	25, 27
Cutting sleeves	21
Elbow bulkhead connectors	24
Elbow connectors	24
Elbow screw-in connectors	24
Four-way connectors	25
L-screw-in connectors	23

Reducing connectors	22, 28
Reducing connections	26
Screw plugs	28
Straight bulkhead connectors	23, 27
Straight connectors	22
Straight screw-in fitting	26
Straight screw-in connectors	23, 27
Straight screw-in glands	22
Tee connectors	25, 27
Tee screw-in connectors	25
Union nuts	22
Vent plug	28

Accessories 29–44

Banjo fitting	36
Check valve	40
Coupling plug	44
Filler coupling	44
Fixing bolts	29
Fixing clips	30
High pressure hoses	34, 35
Hoses	33
Hoses suitable for self-installation	34
Lock washer	29
Nuts	29
Oil level gauges	43
Oil reservoirs	42, 43
Plastic tubing	32
Pressure gauges	37
Quick-disconnect couplings	38
Relief valves	39
Rotating joints	36
Safety valves	40, 41
Shut-off valves	38
Steel tubing	31
Topping-up pumps	44
Tube bending device	31

Solderless pipe union with tapered sleeve acc. to DIN 3862

For pressures up to 45 bar

Counterbores

DIN 3854/DIN 3862 – for solderless tube connection

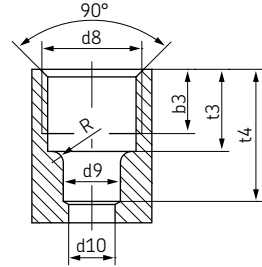

Specification of counterbores	f.tube diam.	d9 ^{B11}	d10	d8	b3	t3	t4	r
1102 ¹⁾	2.5	2.5	1.5	M6×0.75	4.5	5.5	8.5	1.3
1404	4	4	3	M8×1	6.5	8.5	12.5	1.6
1406	6	6	4.5	M10×1	7	9	14	1.6
1408	8	8	6.5	M14×1.5	9	11.5	18.5	1.6
1410	10	10	8.5	M16×1.5	9	11.5	19.5	1.6
1412	12	12	10.5	M18×1.5	9.5	12	22	1.6

¹⁾ not shown in DIN standard

Form counterbores

to tap ports for solderless tube connection

form counterbore Order No.	tube diam.	for counter-bore	l	d1	d2	d10	d4	Twist drill t2	t3
902-111	2.5	1102	60.5	10	1.5	5	4.5	5.5	
904-411	4	1404	65	10	3	6.5	7.5	8.5	
906-411	6	1406	66	12	4.5	8.5	8	9	
908-411	8	1408	70	16	6.5	12	10.5	11.5	
910-411	10	1410	72	18	8.5	14	10.5	11.5	
912-411	12	1412	75	20	10.5	16	11	12	

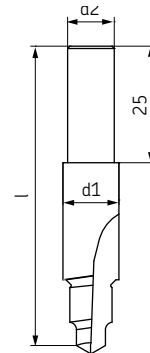

Provision of counterbore

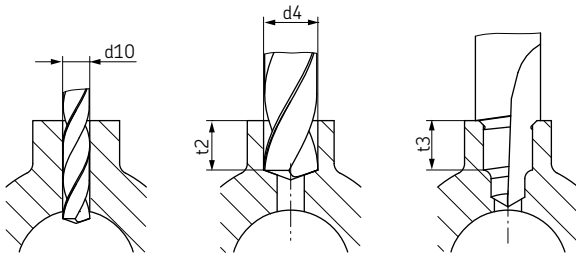

predrill holes

bore hole to be tapped

counterbore with form counterbore up to the stop

Important note #3:

When using a hand drill, take care not to tilt the counterbore out of the drill axis. To avoid damages drill steadily without interruption. Increase pressure slightly at the stop.

Form counterbore enlarges bore hole diam. d4 to core hole for ISO thread.

Solderless pipe union with tapered sleeve acc. to DIN 3862

For pressures up to 45 bar

Connectors for steel and copper tubing

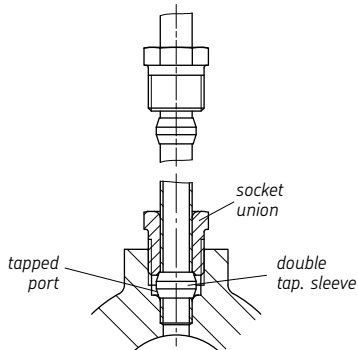

Installation (steel and copper tubing)

1. Push socket union and double tapered sleeve onto tube end.
2. Insert tube end into tapped port up to the stop
3. First tighten socket union finger-tight by hand. Then turn another $1\frac{1}{2}$ turns.

Double tapered sleeves – DIN 3862

Order No.	for tube diam. d	Material
402-001 *)	2.5	brass
404-001	4	
406-001	6	
408-001	8	
410-001	10	
412-001	12	

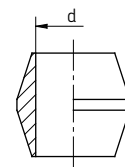

Socket unions – DIN 3871

Order No	for tube diam.	d1	l1	l2	WAF
402-002 *)	2.5	M6×0.75	9	3	7
404-002	4	M8×1	12	4	8
406-002	6	M10×1	13	4	10
408-202	8	M14×1.5	16	4.5	14
410-002	10	M16×1.5	17	5.5	17
412-002	12	M18×1.5	18	6	19

Material: steel, galvanized surface

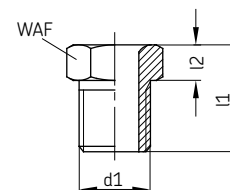

*) not shown in DIN standard

Connectors for steel, copper and plastic tubing

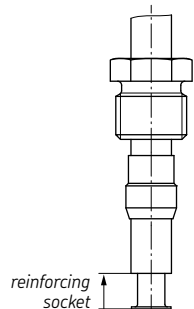

Reinforcing sockets (if plastic tubing is used)

Order No.	for tube	d2	d3	l1
402-603	2.5×0.5	1.4	2.3	8
404-603	4×0.85	2.2	3.8	10
406-603	6×1	3.9	5.8	12
406-613	6×1.25	3.4	5.8	12
408-603	8×1.25	5.4	7.8	15
410-603	10×1.5	6.9	9.8	18
412-603	12×1.5	8.9	11.8	20

Material: brass

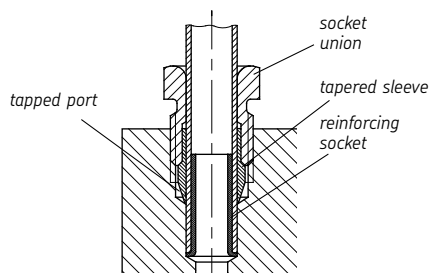
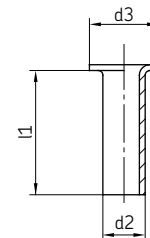

Tapered sleeves – DIN 3862

Order No.	for tube diam. d	Material
402-611	2.5	brass
404-611	4	
406-611	6	
408-611	8	
410-611	10	
412-611	12	

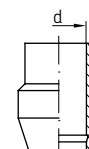

Socket unions – DIN 3871

Order No.	for tube diam.	d1	l1	l2	WAF
402-612	2.5	M6×0.75	9	3	7
404-612	4	M8×1	12	4	8
404-612-MS *)	4	M8×1	12	4	8
406-612	6	M10×1	13	4	10
406-612-MS *)	6	M10×1	13	4	10
408-612	8	M14×1.5	16	4.5	14
408-612-MS *)	8	M14×1.5	16	4.5	14
410-612	10	M16×1.5	17	5.5	17
410-612-MS *)	10	M16×1.5	17	5.5	17
412-612	12	M18×1.5	18	6	19

Material: steel, galvanized surface, *) brass

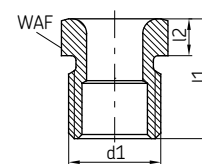

Solderless pipe union with tapered sleeve acc. to DIN 3862

For pressures up to 45 bar

Adaptors

with cylindrical thread (sealed by flat washer to DIN 7603)

Order No.	Tube diam.	d1	d2 *)	l1	l2	WAF
843-130-024	2.5	M3	M6×0.75	22	8.5	7
843-130-025		M4		22	8.5	7
843-130-026		M5		22	8.5	7
402-004		M6		13	5.5	9
402-003		M6×0.75		13	5.5	9
402-006		M8×1		15	7.5	11
404-004	4	M8×1	M8×1	24	14	11
404-005		M8×1		32	22	11
404-061		M5		20	5.5	11
404-063		M8		22	8	11
404-003		M8×1		18	7.5	11
404-006		M10×1		18	7.5	14
404-040		G 1/8 A		18	8	14
404-162		M12×1		18	9	17
404-164		M14×1.5		18	9	17
406-158		6		M8×1	M10×1	23
406-004	M10×1		18	7.5		14
406-162	M12×1		19	9		17
406-054	G 1/4 A		20	10		17
301-005	M14×1.5		18	9		17
406-166	M16×1.5		19	9		19
406-055	G 3/8 A	21	10	22		
408-004	8	M10×1	M14×1.5	28	7.5	17
408-154		G 1/8 A		29	8	17
408-160		G 1/4 A		30	16	17
408-162		M12×1		29	9	17
301-020		G 1/4 A		23	10	17
301-001		M14×1.5		26	9	17
408-005		M16×1.5		22	9	19
408-006		M18×1.5		22	10	22
408-022		M22×1.5		24	12	27
410-160		10		M10×1	M16×1.5	30
410-162	M12×1		31	9		19
410-163	G 1/4 A		30	10		19
410-164	M14×1.5		29	9		19
410-169	G 1/4 A		52	16		19
410-004	M16×1.5		23	9		19
410-018	M18×1.5		24	10		22
410-171	G 1/2 A		24	12		27
410-022	M22×1.5		24	12		27
412-162	12		M12×1	M18×1.5		35
412-163		G 1/4 A	35		10	22
412-164		M14×1.5	33		9	22
412-169		G 1/4 A	41		16	22
412-004		M18×1.5	24		10	22
412-014		M22×1.5	26		12	27

Material: steel, galvanized surface

Order No	Tube diam.	d1	d2	l1	l2	WAF
301-134	4	G 1/4	M10×1	23	7.5	17
301-034	5.5	G 1/4	M14×1.5	22	9	17
267-001.17	6	G 1/8 A	M10×1	24	8	14
406-163		M12×1		19	9	17
D301-005-MS		M14×1.5		20	9	17
406-167		M16×1.5		19	9	19
267-001.19		M18×1.5		21	10	22
D408-004-MS		M10×1		29	7.5	17
D301-001-MS	8	M14×1.5	M14×1.5	28	9	17
D301-020-MS		G 1/4 A		30	10	17
267-001.13		G 1/2 A		24	12	27

Material: brass

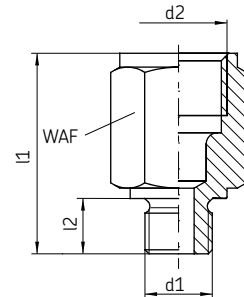

Solderless pipe union with tapered sleeve acc. to DIN 3862

For pressures up to 45 bar

Reducing adapters

with cylindrical thread (sealed by flat washer to DIN 7603)

Order No.	d1	d2	l1	l2	WAF	Material
843-130-021 ¹⁾	M3	M5	22	8.5	3	
843-130-022 ¹⁾	M4	M6	22	8.5	3	steel, galvanized surface
843-130-023 ¹⁾	M5	M7	22	8.5	3	
406-024	M10×1	G 3/8	20	8	14	brass, galvanized surface
401-016-312	M10×1	G 1/4	26.5	7.5	17	brass
406-044-S1	M10×1 tap.	G 3/4	22.5	8	17	steel, galvanized surface
P-78.01	M12×1	G 3/4	27	8.5	19	steel, galvanized surface
401-013-161	G 1/4 A	G 1/2	40	12	27	steel, galvanized surface
401-019-352	M14×1.5	G 3/8	20	9	17	brass
401-016-371	M16×1.5	G 1/4	30	12	19	steel, galvanized surface
243-001.10	M16×1.5	G 1/2	31	9	27	
267-001.47	G 3/8 A	G 1/4	31	10	22	brass
267-001.60	G 3/8 A	G 1/2	34		27	
267-001.36	M18×1.5	G 3/8	32	10	22	steel, galvanized surface
243-001.20	M18×1.5	G 1/2			27	
44-1755-2029	M20×1.5	G 1/4	28	12	24	steel, galvanized surface
401-019-132		G 3/8	24		27	
DZ333		G 1/4	24		27	
401-013-131	G 1/2 A	G 1/2	40.5	12	27	brass
DZ334		G 3/8	31		27	
267-001.03		G 3/4	40		36	
401-011-132	G 1/2 A	G 1	49	14	41	
433-890-131	G 1/2 A	G 1 1/4	53	14	55	steel, galvanized surface
401-013-171	G 3/4 A	G 1/2	41	16	32	
401-013-111	G 1 A	G 1/2	29	18	41	

¹⁾ With female thread

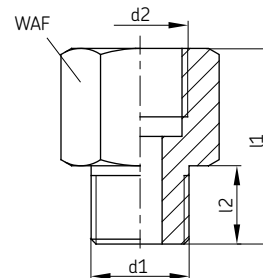

Adaptors

with tapered thread

Tapered threads are used **without washers**, as they are **self-sealing**.
It is not necessary to provide the ports with seal faces.

Order No.	Tube diam.	d1 ¹⁾	d2	l1	l2	WAF	Material
402-003K	2.5	M6×0.75 tap.	M6×0.75	11.5	4.5	8	
402-006K		M8×1 tap.		15	8	9	
402-008K		M10×1 tap.		16	7.5	12	
404-662K	4	M6 tap.	M8×1	19	5	11	
404-663K		M6 tap.		20	6	11	
404-673K		M6×0.75 tap.		20	6	11	
404-047K		M7 tap.		20	6	11	
404-003K		M8×1 tap.		17	7.4	11	
404-045		M8×1 tap.		62.5	7.4	11	
404-006K		M10×1 tap.		16	7.4	11	steel, galvanized surface
401-004-512		M10×1 tap.		25	7.4	11	
404-040K		R 1/8 tap.		16	6	11	
404-040K-US		1/8 NPTF		20	6.7	11	
404-054K		R 1/4 tap.		14	9	14	
404-072		1/4-28 UNF		20	5.6	11	
401-004-903	1/4 BSF	20	5	11			
401-004-904	1/16 BSF	18	5	11			
406-004K	6	M10×1 tap.	M10×1	23	7.4	14	
301-105K		M12×1 tap.		18	7.4	14	
456-004K		R 1/8 tap.		21	6	14	
406-054K		R 1/4 tap.		20	9	17	

¹⁾ Tapered thread according to DIN 158. short, resp. according to DIN 2999

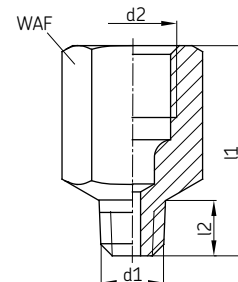

Solderless pipe union with tapered sleeve acc. to DIN 3862

For pressures up to 45 bar

Bulkhead connectors

with tapered thread (for sealed tube passage through a wall without tube interruption)

Order No.	Tube diam.	d1 ¹⁾	d2	l1	l2	WAF
404-003DK	4	M8×1 tap.	M8×1	17	7.4	11
404-006DK	4	M10×1 tap.	M8×1	16	7.4	11
406-004DK	6	M10×1 tap.	M10×1	18	7.4	14
301-001DK	8	M14×1.5 tap.	M14×1.5	24	11	17
410-004DK	10	M16×1.5 tap.	M16×1.5	24	11	19

Material: steel, galvanized surface

¹⁾ Tapered thread according to DIN 158. short

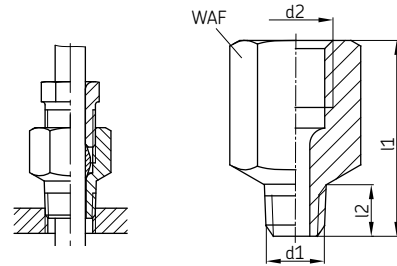

Elbows

with tapered thread

Order No.	Tube diam.	d1 ¹⁾	d2)	d3	d4	l1	l2	l3	WAF
504-510K	4	M10×1 tap.	M8×1	13	13	21	16	10	14
514-018K	4	R 1/8 tap.	M8×1	13	13	21	16	10	
506-508K	6	M8×1 tap.	M10×1	12.5	14	18	18	10.5	
506-510K	6	M10×1 tap.	M10×1	12.5	14	18	18	10.5	
506-512K	6	M12×1 tap.	M10×1	12.5	14	18	18	10.5	
508-512K	8	M12×1 tap.	M14×1.5	14	19.5	19.5	24	10	

Material: die-cast zinc

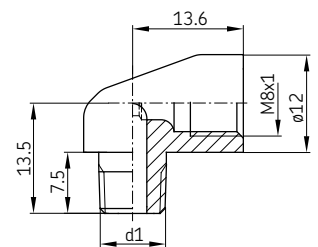
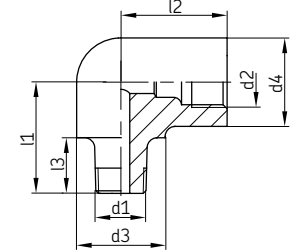
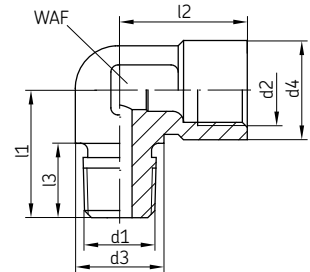

Order No.	Tube diam.	d1 ¹⁾	d2	d3	d4	l1	l2	l3	Material
502-206K	2.5	M6 tap.	M6×0.75	-	8	10	9.5	6	steel
506-202K	6	M10×1 tap.	M10×1	17	17	22	21	11	brass
403-006-651	6	R 1/4 tap.	M10×1	14	14	17	17.5	8.5	steel

Order No.	Tube diam.	d1 ¹⁾	Material
504-200K		M6 tap.	brass
504-201K	4	M8×1 tap.	
504-202K		M10×1 tap.	
504-203K		M6×0.75 tap.	

¹⁾ Tapered thread according to DIN 158. short, resp. according to DIN 2999

Elbows

Order No.	d	d1	l1	l2	Fig.
406-145K	M8×1 tap.	M10×1	7.5	21	1
406-045K	M10×1 tap.	M10×1	7.5	21	1
406-089K	M8×1 tap.	M10×1	11	24	2
406-090K	M10×1 tap.	M10×1	11	24	2
406-091K	R 1/8 tap.	G 1/8	11	24	2
406-092K	M10×1 tap.	M10×1	17	30	2
406-093K	R 1/8 tap.	M10×1	11	24	2

Material: steel, galvanized surface

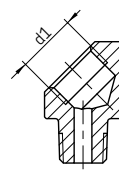

Fig. 1

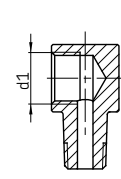
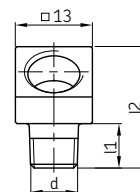
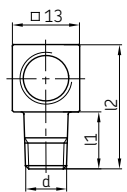

Fig. 2



Solderless pipe union with tapered sleeve acc. to DIN 3862

For pressures up to 45 bar

Elbows

with tube end (for installation in counterbores as per DIN 3854/DIN 3862)

Order No.	Tube diam. d1	d2	d3	d4	l1	l2	l3
DY958	6	6	M10×1	8	14	30.8	21
DY960	8	8	M14×1.5	11	18	37	24.5
DY961	10	10	M16×1.5	15	23	42.5	26.5
DY962	12	12	M18×1.5	15	23	46	26.5

Tube end for tube connection

Material: brass

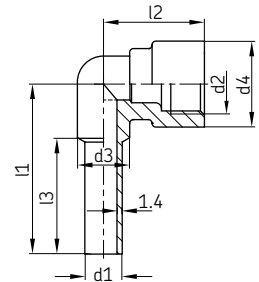

Screw plugs (sealed by flat washer to DIN 7603)

Order No.	d1	d2	l1	l2	l3	WAF	Material
DIN910-R1-8-5.8	G 1/8 A	14	17	8	3	11	steel, galvanized surface
DIN910-R1-4×8-5.8	G 1/4 A	18	17	8	3	14	
DIN910-R3-8-5.8	G 3/8 A	22	21	12	3	17	
DIN910-R1-2-5.8	G 1/2 A	26	26	14	4	19	
DIN910-R3-4-5.8	G 3/4 A	32	30	16	4	24	
DIN910-R1-5.8	G 1 A	39	32	16	5	27	steel, galvanized surface
402-011	M6×0.75		9	5		9	
404-011	M8×1		9.5	5.5		11	
406-011	M10×1		12	7		12	
408-211	M12×1		12	7		17	
408-011	M14×1.5		12	7		17	
410-011	M16×1.5		14	8		19	
412-011	M18×1.5		15	10		22	
DIN 908-M10×1-5.8 ¹⁾	M10×1	14	11	8	3	5	
DIN 908-M12×1-5.8 ¹⁾	M12×1	17	15	12	3	6	
DIN 908-M14×1-5.8 ¹⁾	M14×1	19	15	12	3	6	

¹⁾ Hexagon socket

Vent plugs

Order No.	d1	d2	l1	l2	Material
833-330-016	M10×1	14	17	8	steel,
833-330-021	G 1/8 A				galvanized surface

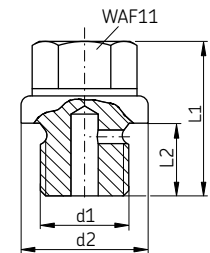
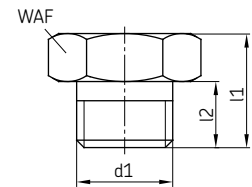
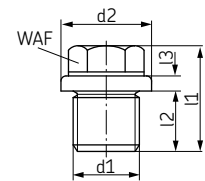

Flat washers

Order No.	d1	d2	h	Suitable for thread		Material
				mm	inches	
DIN7603-A6×10-CU	6.2	9.9	1	M6	-	copper
DIN7603-A8×11.5-CU	8.2	11.4	1	M8	-	
504-019	10.2	13.9	1	M10	G 1/8	
508-215-CU	12.2	15.9	1.4	M12	-	
508-320-CU	12.2	15.9	2	M12	-	
DIN7603-A14×18-CU	14.2	17.9	1.5	M14	-	copper
508-108	13.3	17.9	1.5	-	G 1/4	
DIN7603-A16×20-CU	16.2	19.9	1.5	M16	-	
DIN7603-A17×21-CU	17.2	20.9	1.5	-	G 3/8	
DIN7603-A18×22-CU	18.2	21.9	1.5	M18	-	
DIN7603-A20×24-CU	20.2	23.9	1.5	M20	-	
DIN7603-A21×26-CU	21.2	25.9	1.5	-	G 1/2	
DIN7603-A22×27-CU	22.2	26.9	1.5	M22	-	
DIN7603-A27×32-CU	27.3	31.9	2	M27	-	
DIN7603-A30×36-CU	30.3	35.9	2	M30	-	
DIN7603-A33×39-CU	33.3	38.9	2	M33	-	

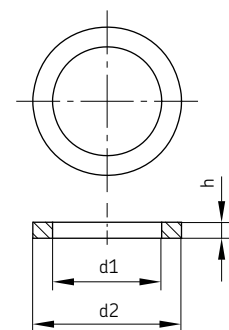

Solderless pipe union with tapered sleeve acc. to DIN 3862

For pressures up to 45 bar

Threaded sockets

Order No.	d1	l	WAF	Material
404-203	M8×1	13	3.5	steel
406-203	M10×1	15	3.5	
406-243-B ¹⁾	M10×1	18	3.5	
408-243-B ¹⁾	M12×1	19	5.5	
458-012	M12×1	17	5.5	
458-012-B ¹⁾	M12×1	17	5.5	
408-023	M14×1.5	18	5.5	
410-003	M16×1.5	19	7	
410-003-B ¹⁾	M16×1.5	19	7	
408-033-S3	G ¹ / ₄ A	15	5.5	

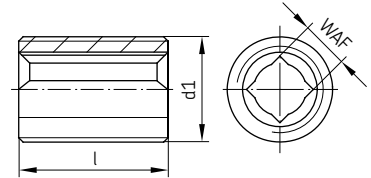

¹⁾ Coated with micro-encapsulated adhesive

Order No.	d1	d2	d3	l	l1	l2	WAF	Material
406-103	M10×1	M12×1	5	20	6	7	14	steel,
408-103	M12×1	M14×1.5	6	21	7	7	17	galvanized
853-750-024	G ¹ / ₄ A	G ¹ / ₄ A	7	31	10.5	10.5	19	surface

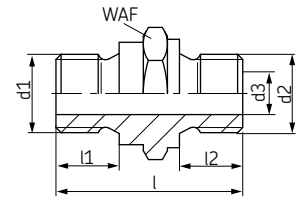

Order No.	d1	d3	l	Material
406-233	M10×1	4	26	brass

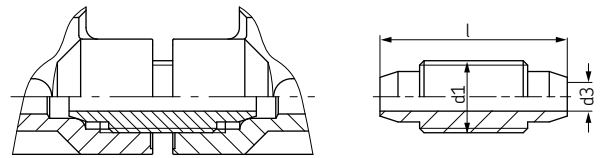

Distributor connection

Connectors

Order No.	Tube diam.	d1	d2	d3	l	l1	WAF	Material
404-008	4	M14×1.5	M8×1	M8×1	27	19	17	steel, galvanized surface
404-009	4	M14×1.5	M8×1	M8×1	38	30	17	
406-008	6	M14×1.5	M10×1	M10×1	30	20	17	
406-005	6 / 8	M16×1.5	M14×1.5	M10×1	35	23	19	
408-008	8	M20×1.5	M14×1.5	M14×1.5	40	28	24	
410-008	10	M20×1.5	M16×1.5	M16×1.5	42	27	24	
412-008	12	M24×1.5	M18×1.5	M18×1.5	48	33	27	
44-1755-2019 ¹⁾		R ¹ / ₄	M10×1		33		24	

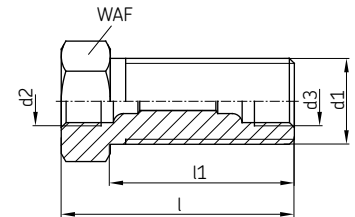

¹⁾ Hexagon socket

Order No.	Tube diam.	d2	d3	ø d4	l	l1	WAF	Material
404-010	4	M8×1	M8×1	10.8	27	13	11	steel, galvanized surface
406-010	6	M10×1	M10×1	13.8	30	10	14	
406-805	6 / 8	M14×1.5	M10×1	16.8	35	11	17	
408-010	8	M14×1.5	M14×1.5	16.8	40	14	17	
410-010	10	M16×1.5	M16×1.5	18.8	42	13	19	
412-010	12	M18×1.5	M18×1.5	21.8	48	18	22	

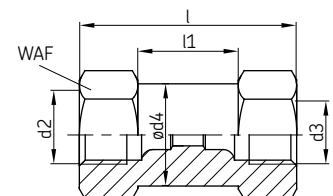

Solderless pipe union with tapered sleeve acc. to DIN 3862

For pressures up to 45 bar

Elbow connectors

Order No.	Tube diam.	d1	d2	d3	d4	l1	l2	l3	Material
504-003	4		M8×1	18	12	33	16	22	die-cast zinc
504-103	4	M14×1.5	M8×1	18	12	33	18	22	brass
506-004	6		M10×1	16.5	14	27	17.5	15	brass

Order No.	Tube diam.	d2	d3	d4	l1	l2	Material
408-013	8	M14×1.5	20	20	23.5	23.5	die-cast zinc
410-013	10	M16×1.5	21	21	26	26	

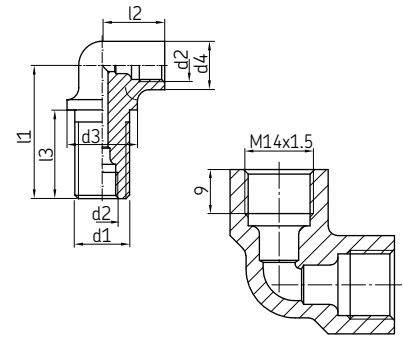

Bracketed connectors

Order No.	Tube diam.	Material
504-004	4	die-cast zinc

Order No.	Tube diam.	Material
506-010	6	brass

Order No.	Tube diam.	d	b	h	l	Material
DAR506	6	M10×1	15	20	12	aluminum
DAR508	8	M14×1.5	20	25	15	

Order No.	Tube diam.	d1	d2	Material
DAR510	10	M16×1.5	M16×1.5	steel, galvanized surface
DAR510-S1	8 / 10	M14×1.5		

Order No.	Tube diam.	Material
DAR524	4	steel, galvanized surface

Order No.	Tube diam.	Material
DAR534	4	steel, galvanized surface

Tube-to-tube-connector with air vent

Order No.	Tube diam.	d	b	h	l	Material body
995-001-104	4	M8×1	20	50	40	aluminum
995-001-106	6	M10×1				

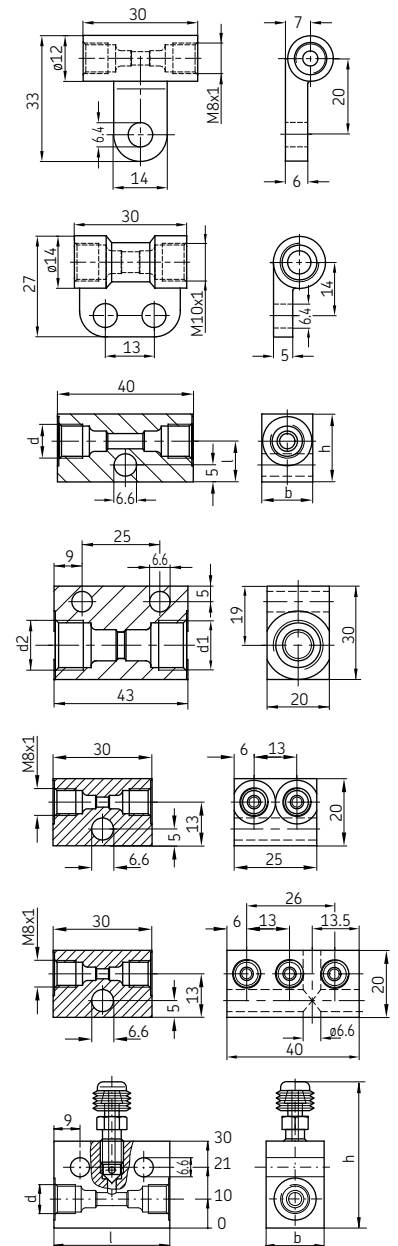

Solderless pipe union with tapered sleeve acc. to DIN 3862

For pressures up to 45 bar

Tee connectors

Order No.	Tube diam.	d1	d2	d3	l1	l2	Material
504-008	4	M8×1	M8×1	12	15	30.5	die-cast zinc
506-408	6 / 4	M10×1	M8×1	14	18	36	
506-008	6	M10×1	M10×1	14	18	36	
510-102	10	M16×1.5	M16×1.5	20	25	50	

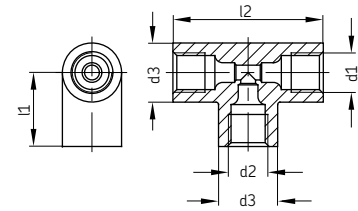

Order No.	Tube diam.	d2	Material
508-602-2	8 / 6	M10×1	die-cast zinc
508-002-2	8	M14×1.5	

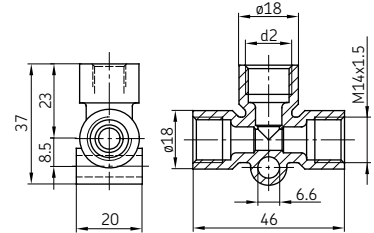

Order No.	Tube diam.	Material
504-045	4	die-cast zinc

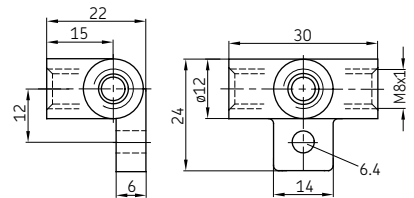

Order No.	Tube diam.	d1	d2	l1	l2	l3	l4	Material
DY964	6	M10×1	6	40	22	32	37	brass
DY966	8	M14×1.5	8	45	25	36	46	

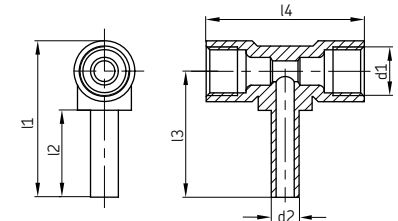

Order No.	Tube diam.	d1	d2	d3	a	b	c	h	h1	l1	l2
DAT506	6	M10×1	M10×1	6.6	22	20	9	30	9	40	20
DAT508	8	M14×1.5	M14×1.5	6.6	32	20	9	40	9	50	29
DAT510 ¹⁾	10	M16×1.5	M16×1.5	7	25	20	13.5	40	15	52	29
DAT510-S5	6	M16×1.5	M10×1	7	25	25	13.5	40	15	52	29
DAT512	12	M18×1.5	M18×1.5	6.6	42	25	9	40	9	60	29

Material: aluminum, ¹⁾ steel, galvanized surface

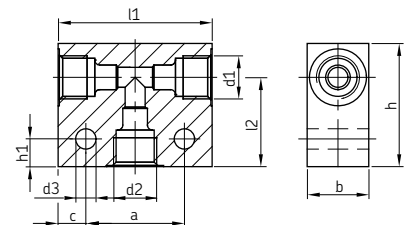

Order No.	Tube diam.	Material
DAT510-S1	8 (1×) 10 (2×)	steel, galvanized surface

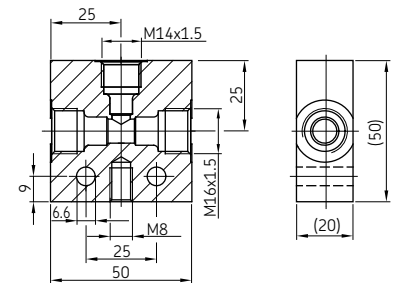

Solderless pipe union with tapered sleeve acc. to DIN 3862

For pressures up to 45 bar

Distributor manifold

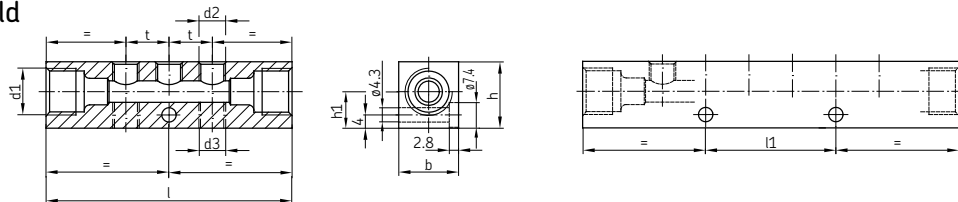

Main tube port tube diam.	Order No.	Number of port	d1	d2	d3	l	l1	h	h1	b	t
4	322-541	2	M8×1	2x M8×1	-	49	-	17	10.5	13	13
	323-541	3	M8×1	3x M8×1	-	62	-	17	10.5	13	13

Main tube port tube diam.	Order No.	Number of port	d1	d2	d3	l	l1	h	h1	b	t
6	321-661	1	M10×1	M10×1	-	41	-	20	11	18	-
	322-661	2	M10×1	2x M10×1	-	58	-	20	11	18	17
	323-661	3	M10×1	3x M10×1	-	75	-	20	11	18	17
	324-761	4	M10×1	4x M10×1	-	92	34	20	11	18	17
	325-861	5	M10×1	5x M10×1	-	109	51	20	11	18	17
	326-661	6	M10×1	6x M10×1	-	126	68	20	11	18	17
	328-761	8	M10×1	8x M8×1	-	160	52	20	11	18	17
	329-761	9	M10×1	9x M10×1	-	177	119	20	11	18	17
	330-761	10	M10×1	10x M10×1	-	194	136	20	11	18	17
	331-761	11	M10×1	11x M10×1	-	211	153	20	11	18	17
	332-761	12	M10×1	12x M10×1	-	228	170	20	11	18	17

Main tube port tube diam.	Order No.	Number of port	d1	d2 (above)	d3 (below)	l	l1	h	h1	b	t
6	322-861	2	M10×1	2x M10×1	2x M10×1	41	-	20	11	18	-
	324-861	4	M10×1	2x M10×1	2x M10×1	58	-	20	11	18	17
	326-563	6	M10×1	3x M10×1	3x M10×1	77	52	17	11	18	19
	328-861	8	M10×1	4x M10×1	4x M10×1	92	34	20	11	18	17
	330-861	10	M10×1	5x M10×1	5x M10×1	109	51	20	11	18	17
	332-861	12	M10×1	6x M10×1	6x M10×1	126	68	20	11	18	17
	334-861	14	M10×1	7x M10×1	7x M10×1	143	85	20	11	18	17
	336-861	16	M10×1	8x M10×1	8x M10×1	160	102	20	11	18	17
	338-861	18	M10×1	9x M10×1	9x M10×1	177	119	20	11	18	17
	340-861	20	M10×1	10x M10×1	10x M10×1	194	136	20	11	18	17
	342-861	22	M10×1	11x M10×1	11x M10×1	211	153	20	11	18	17
	344-861	24	M10×1	12x M10×1	12x M10×1	228	170	20	11	18	17

Main tube port tube diam.	Order No.	Number of port	d1	d2	d3	l	l1	h	h1	b	t
6	322-561	2	M10×1	2x M8×1	-	52	-	17	10.5	13	13
	323-561	3	M10×1	3x M8×1	-	65	-	17	10.5	13	13
	324-561	4	M10×1	4x M8×1	-	78	-	17	10.5	13	13
	325-565	5	M10×1	5x M8×1	-	91	-	17	10.5	13	13
	326-562	6	M10×1	6x M8×1	-	104	52	20	11	18	13
	327-564	7	M10×1	7x M8×1	-	117	39	20	11	18	13
	328-561	8	M10×1	8x M8×1	-	130	52	17	10.5	13	13
	329-561	10	M10×1	10x M8×1	-	156	78	17	10.5	13	13

Main tube port tube diam.	Order No.	Number of port	d1	d2	d3	l	l1	h	h1	b	t
8	321-581	1	M14×1.5	1x M8×1	-	48	-	20	11	18	-
	322-581	2	M14×1.5	2x M8×1	-	61	-	20	11	18	13
	322-661-S1	2	M14×1.5	2x M10×1	-	72	-	20	11	18	22
	323-581	3	M14×1.5	3x M8×1	-	74	-	20	11	18	13
	323-661-S1	3	M14×1.5	3x M10×1	-	94	-	20	11	18	22
	324-581	4	M14×1.5	4x M8×1	-	87	-	20	11	18	13
	325-581	5	M14×1.5	5x M8×1	-	74	-	20	11	18	13
	326-581	6	M14×1.5	6x M8×1	-	113	39	20	11	18	13
	327-581	7	M14×1.5	7x M8×1	-	126	52	20	11	18	13
	328-581	8	M14×1.5	8x M8×1	-	139	65	20	11	18	13
	329-581	9	M14×1.5	9x M8×1	-	152	78	20	11	18	17
	330-581	10	M14×1.5	10x M8×1	-	165	91	20	11	18	13
330-581-S1	10	M14×1.5	10x M8×1	-	201	85	20	11	18	17	
331-581	11	M14×1.5	11x M8×1	-	178	104	20	11	18	13	
332-581	12	M14×1.5	12x M8×1	-	191	117	20	11	18	13	

Material: aluminum alloy

Solderless pipe union with tapered sleeve acc. to DIN 3862

For pressures up to 45 bar

Standard manifolds, configurable *)

Order code

V **L** - [] [] [] [] [] []

Product series

Number of ports

01 = 1 port **05** = 5 ports
02 = 2 ports **06** = 6 ports
03 = 3 ports **08** = 8 ports
04 = 4 ports **10** = 10 ports

Design of outlet thread

A = Standard profile, M8x1 with counterbore for flat washer or O-ring
B = Standard profile, M10x1 with counterbore for flat washer or O-ring
C = Standard profile, M14x1.5 with counterbore for flat washer or O-ring
D = Small profile, M8x1 with surface suitable for sealing with flat washer
E = Small profile, M10x1 with surface suitable for sealing with flat washer

Material

A = Aluminum; **E** = Stainless steel (only for outlet threads **A+B**)

Design of main line connection

G1 = G¹/₈ to DIN 3862, Form X, small
G2 = G¹/₄ to DIN 3862, Form X, small
M1 = M10x1 to DIN 3862, Form X, small
M2 = M14x1.5 to DIN 3862, Form X, small
M3 = M10x1 with counterbore for solderless pipe connection per DIN 3862
M4 = M14x1.5 with counterbore for solderless pipe connection per DIN 3862
 (can only be selected for normal profile)

Order example

VL-02AAM3

- Product series VL
- 2 ports
- Standard profile made of aluminum
- M8x1 internal thread with counterbore for flat washer or O-ring
- M10x1 main line connection with counterbore for solderless pipe connection per DIN 3862

Distributor manifold

Standard profile A

¹⁾ For solderless pipe connection per DIN 3862
²⁾ DIN 3852-3 Form W

Main line connection d1	Number of ports	Dimensions [mm]					
		A	B	C	E	F	
M10x1 (M3)	1	40	20	-	20	-	
	2	55	27.5	-	20	1x15	
	3	70	27.5	15	20	2x15	
	4	85	27.5	30	20	3x15	
	5	100	27.5	45	20	4x15	
	6	115	27.5	60	20	5x15	
	8	145	27.5	90	20	7x15	
	10	175	27.5	120	20	9x15	
	M10x1 (M1) G ¹ / ₈ (G1)	1	34	17	-	17	-
		2	49	24.5	-	17	1x15
3		64	24.5	15	17	2x15	
4		79	24.5	30	17	3x15	
5		94	24.5	45	17	4x15	
6		109	24.5	60	17	5x15	
8		139	24.5	90	17	7x15	
10		169	24.5	120	17	9x15	
M14x1.5 (M4)		1	48	24	-	24	-
		2	63	31.5	-	24	1x15
	3	78	31.5	15	24	2x15	
	4	93	31.5	30	24	3x15	
	5	108	31.5	45	24	4x15	
	6	123	31.5	60	24	5x15	
	8	153	31.5	90	24	7x15	
	10	183	31.5	120	24	9x15	
	M14x1.5 (M2) G ¹ / ₄ (G2)	1	46	23	-	23	-
		2	61	30.5	-	23	1x15
3		76	30.5	15	23	2x15	
4		91	30.5	30	23	3x15	
5		106	30.5	45	23	4x15	
6		121	30.5	60	23	5x15	
8		151	30.5	90	23	7x15	
10		181	30.5	120	23	9x15	

*) See also www.cadenas.com

Solderless pipe union with tapered sleeve acc. to DIN 3862

For pressures up to 45 bar

Distributor manifold

Standard profile B

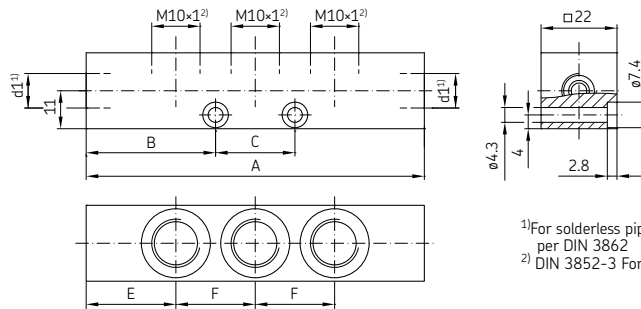

¹⁾ For solderless pipe connection per DIN 3862
²⁾ DIN 3852-3 Form X, small

Main line connection d1	Number of ports	Dimensions [mm]					
		A	B	C	E	F	
M10x1 (M3)	1	40	20	-	20	-	
	2	57	28.5	-	20	1x17	
	3	74	28.5	17	20	2x17	
	4	91	28.5	34	20	3x17	
	5	108	28.5	51	20	4x17	
	6	125	28.5	68	20	5x17	
	8	159	28.5	102	20	7x17	
	10	193	28.5	136	20	9x17	
	M10x1 (M1) G ¹ / ₈ (G1)	1	34	17	-	17	-
		2	51	25.5	-	17	1x17
3		68	25.5	17	17	2x17	
4		85	25.5	34	17	3x17	
5		102	25.5	51	17	4x17	
6		119	25.5	68	17	5x17	
8		153	25.5	102	17	7x17	
10		187	25.5	136	17	9x17	

Main line connection d1	Number of ports	Dimensions [mm]					
		A	B	C	E	F	
M14x1.5 (M4)	1	52	26	-	26	-	
	2	69	34.5	-	26	1x17	
	3	86	34.5	17	26	2x17	
	4	103	34.5	34	26	3x17	
	5	120	34.5	51	26	4x17	
	6	137	34.5	68	26	5x17	
	8	171	34.5	102	26	7x17	
	10	205	34.5	136	26	9x17	
	M14x1.5 (M2) G ¹ / ₄ (G2)	1	46	23	-	23	-
		2	63	31.5	-	23	1x17
3		80	31.5	17	23	2x17	
4		97	31.5	34	23	3x17	
5		114	31.5	51	23	4x17	
6		131	31.5	68	23	5x17	
8		165	31.5	102	23	7x17	
10		199	31.5	136	23	9x17	

Distributor manifold

Standard profile C

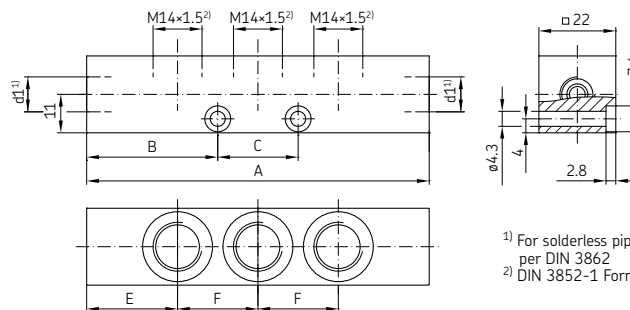

¹⁾ For solderless pipe connection per DIN 3862
²⁾ DIN 3852-1 Form X, small

Main line connection d1	Number of ports	Dimensions [mm]				
		A	B	C	E	F
M10x1 (M3)	1	60	18	24	30	-
	2	70	35	-	23	1x24
	3	94	35	24	23	2x24
	4	118	35	48	23	3x24
	5	142	35	72	23	4x24
	6	166	35	96	23	5x24
	8	214	35	144	23	7x24
	10	262	35	192	23	9x24

Main line connection d1	Number of ports	Dimensions [mm]				
		A	B	C	E	F
M14x1.5 (M4)	1	68	22	24	34	-
	2	78	39	-	27	1x24
	3	102	39	24	27	2x24
	4	126	39	48	27	3x24
	5	150	39	72	27	4x24
	6	174	39	96	27	5x24
	8	222	39	144	27	7x24
	10	270	39	192	27	9x24

Solderless pipe union with tapered sleeve acc. to DIN 3862

For pressures up to 45 bar

Distributor manifold

Small profile D

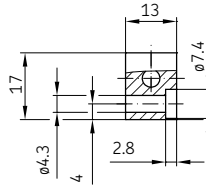
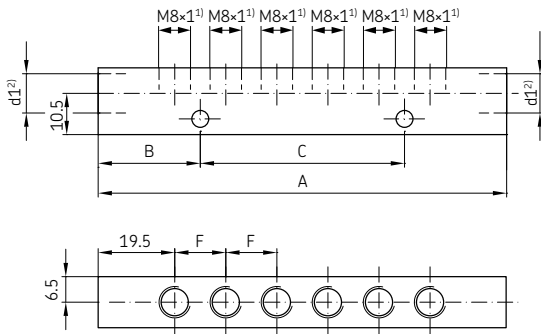

- ¹⁾ Depth 5.5 mm with surface suitable for flat washers
- ²⁾ DIN 3852-3 Form W

Main line connection d1	Number of ports	Dimensions [mm]			
		A	B	C	F
M10x1 (M3)	1	39	19.5	-	-
	2	52	26	-	1x13
	3	65	32.5	-	2x13
	4	78	39	-	3x13
	5	91	45.5	-	4x13
	6	104	26	52	5x13
	8	130	39	52	7x13
	10	156	39	78	9x13

Small profile E

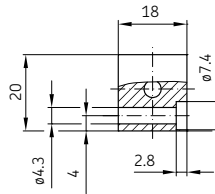
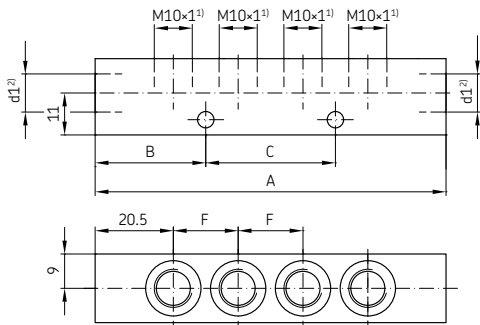

- ¹⁾ Depth 8 mm
- ²⁾ For solderless pipe connection per DIN 3862

Main line connection d1	Number of ports	Dimensions [mm]			
		A	B	C	F
M10x1 (M3)	1	41	20.5	-	-
	2	58	26	-	1x17
	3	75	37.5	-	2x17
	4	92	29	34	3x17
	5	109	29	51	4x17
	6	126	29	68	5x17
	8	160	29	102	7x17
	10	194	29	136	9x17

Solderless pipe union with tapered sleeve acc. to DIN 3862

For pressures up to 45 bar

Cross joints

Order No.	Tube diam.	d1	a	b	h	l1	l2	Material
DAK504-S1	4/6	M10×1/M8×1	22	20	40	40	20	aluminum
DAK506	6	M10×1	22	20	40	40	20	
DAK508	8	M14×1.5	32	20	50	50	25	
DAK510	10	M16×1.5	25	20	56	50	28	
DAK512	12	M18×1.5	42	25	60	60	30	

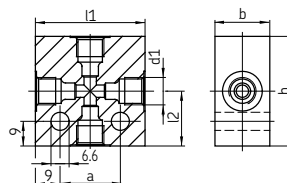

Order No.	Tube diam.	d1	Material
DAK510-S1	10	M16×1.5	steel, galvanized surface

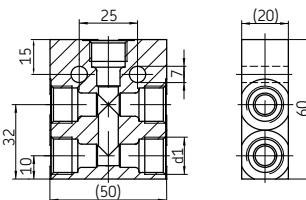

Banjo fittings

Elbow	Order No.	Tube diam.	d1	d2	l1	l2	l3	l4	WAF
	502-161 ¹⁾	2.5	M6	M6×0.75	20	13	19	4.5	9
	502-101 ¹⁾	2.5	M6×0.75	M6×0.75	18	13	19	5	9
	502-102 ¹⁾	2.5	M8×1	M6×0.75	20	14	21	6.5	11
	504-161 ¹⁾	4	M6	M8×1	20	17	24	4.1	9
	504-162 ¹⁾	4	M6×0.75	M8×1	18	17	24	4.5	9
	504-411 ¹⁾	4	M8	M8×1	23	18	25	7.5	11
	504-401 ¹⁾	4	M8×1	M8×1	20	18	25	7	11
	504-101	4	M8×1	M8×1	26	18	25	6.5	11
	504-102	4	M10×1	M8×1	26	19	27.5	6.5	14
	504-108	4	G 1/8 A	M8×1	27	19	27.5	6.8	14
	506-140	6	M10×1	M10×1	26	21	28.5	6.5	14
	506-142	6	M12×1	M10×1	34	25	35.2	7.5	17
	506-012	6	M14×1.5	M10×1	34	25	35.2	7.5	17
	506-145	6	M16×1.5	M10×1	35	30	41	8.7	19
	506-108	6	G 1/8 A	M10×1	27	21	28.5	7	14
	506-214	6	G 3/4 A	M10×1	35	25	35.2	8.5	17
	508-142	8	M12×1	M14×1.5	34	27	37	7.5	17
	508-144	8	M14×1.5	M14×1.5	34	27	37	7.5	17
	508-145	8	M16×1.5	M14×1.5	35	30	41	8.7	19
	508-024	8	G 1/4 A	M14×1.5	35	27	37	8.5	17
	510-142	10	M12×1	M16×1.5	34	30	40	7.5	17
	510-145	10	M16×1.5	M16×1.5	35	30	41	10.7	19
	510-024	10	G 3/4 A	M16×1.5	35	30	40	7.5	17

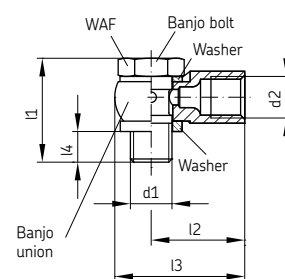

¹⁾ Miniature design

L-type	Order No.	Tube diam.	d1	d2	d3	l1	l2	l3	l4	WAF
	504-114	4	M8×1	M8×1	M8×1	31	18	25.5	6.5	11
	504-115	4	M10×1	M8×1	M8×1	31	19	27.5	6.5	14
	504-105	4 / 6	M10×1	M8×1	M10×1	33	19	27.5	6.5	14
	405-619-061	4 / 6	G 1/8 A	M8×1	M10×1	33	19	27.5	6.3	14
	506-114	6	M10×1	M10×1	M10×1	33	21	28.5	6.3	14
	506-342	6	M12×1	M10×1	M10×1	38	25	35.2	7.5	17
	506-101	6	M14×1.5	M10×1	M10×1	40	25	35.2	7.5	17
	586-342	6 / 8	M12×1	M10×1	M14×1.5	44	25	35.2	7.5	17
	506-013	6 / 8	M14×1.5	M10×1	M14×1.5	43	25	35.2	7.5	17
	506-345	6 / 10	M12×1	M10×1	M16×1.5	48.5	25	35	7.7	19
	506-346	6 / 10	M16×1.5	M10×1	M16×1.5	50	30	41	8.7	19
	508-342	8	M12×1	M14×1.5	M14×1.5	44	27	37	7.5	17
	508-012	8	M14×1.5	M14×1.5	M14×1.5	43	27	37	7.5	17
	508-034	8	G 1/4 A	M14×1.5	M14×1.5	44	27	37	7.5	17
	568-342	8 / 6	M12×1	M14×1.5	M10×1	38	27	37	7.5	17
	508-304	8 / 6	M14×1.5	M14×1.5	M10×1	40	27	37	7.5	17
	508-345	8 / 10	M12×1	M14×1.5	M16×1.5	48.5	27	37	7.7	19
	508-346	8 / 10	M16×1.5	M14×1.5	M16×1.5	50	30	41	8.7	19
	510-342	10	M12×1	M16×1.5	M16×1.5	48.5	30	40	7.5	19
	510-344	10	M16×1.5	M16×1.5	M16×1.5	50	30	41	8.7	19
	510-343	10	G 3/4 A	M16×1.5	M16×1.5	48.5	30	40	7.5	19
	510-346	10 / 6	M16×1.5	M16×1.5	M10×1	50	30	41	8.7	19
	510-341	10 / 8	M12×1	M16×1.5	M14×1.5	44	30	40	7.5	17

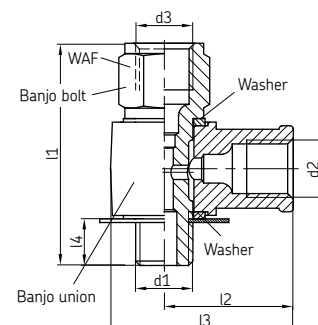

Solderless pipe union with tapered sleeve acc. to DIN 3862

For pressures up to 45 bar

Banjo fittings

Tee	Order No.	Tube diam.	d1	d2	l1	l2	l3	WAF
	504-109	4	M8×1	M8×1	26	38	6.5	11
	504-112	4	M10×1	M8×1	26	38	6.5	14
	506-242	6	M12×1	M10×1	34	48	7.5	17
	506-025	6	M14×1.5	M10×1	34	48	7.5	17
	508-242	8	M12×1	M14×1.5	34	54	7.5	17
	508-013	8	M14×1.5	M14×1.5	34	54	7.5	17
	508-025	8	G 3/4 A	M14×1.5	35	54	7.5	17
	510-242	10	M12×1	M16×1.5	34	60	7.5	17

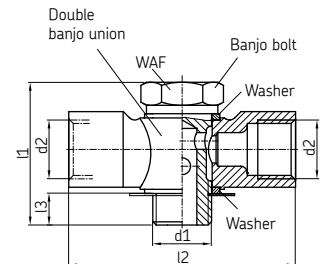

Cross	Order No.	Tube diam.	d1	d2	d3	l1	l2	l3	WAF
	504-110	4	M8×1	M8×1	M8×1	31	38	6.5	11
	504-111	4	M10×1	M8×1	M8×1	31	38	6.5	14
	504-106	4 / 6	M10×1	M8×1	M10×1	33	38	6.5	14
	506-442	6	M12×1	M10×1	M10×1	38	48	7.5	17
	506-014	6	M14×1.5	M10×1	M10×1	40	48	7.5	17
	586-442	6 / 8	M12×1	M10×1	M14×1.5	44	48	7.5	17
	506-026	6 / 8	M14×1.5	M10×1	M14×1.5	43	48	7.5	17
	508-442	8	M12×1	M14×1.5	M14×1.5	44	54	7.5	17
	508-014	8	M14×1.5	M14×1.5	M14×1.5	43	54	7.5	17
	568-442	8 / 6	M12×1	M14×1.5	M10×1	38	54	7.5	17
	508-305	8 / 6	M14×1.5	M14×1.5	M10×1	40	54	7.5	17
	510-442	10	M12×1	M16×1.5	M16×1.5	48.5	60	7.5	19

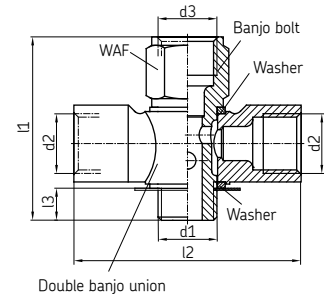

SKF Quick Connectors

For pressures up to 300 bar (metal tube with claw groove)

Tools for the preparation of claw grooves on the ends of steel tubes

Tube cutter

for tube diam.	Tube cutter Order No.	Cutting wheel Order No.
4	169-000-336	844-330-006
6	169-000-337	844-330-007
8	169-000-338	844-330-007

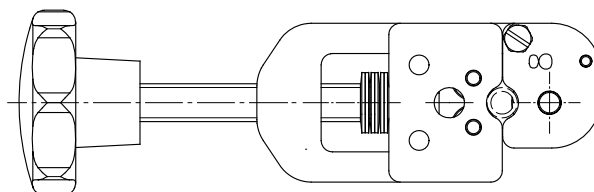

Claw groove

for tube diam.	a ^{+0.3}	b ^{+0.2}	c
4	3.1	5.0	0.3 ... 0.7
6	4.9	6.2	0.4 ... 0.9
8	6.9	6.2	0.5 ... 0.9

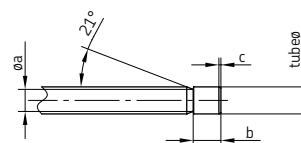

Adaptors

with cylindrical thread

Order No.	Tube diam.	A	G	D	ø B	ø C	l	WAF1	WAF2	Seal
404-003-VS	4		M8×1	6	8.8	11.5	23.8	10	2.5	NBR
404-006-VS	4		M10×1	6	8.8	13.5	23.8	12	2.5	NBR
404-006-S8-VS	4		M10×1	6	8.8	13.5	23.8	12	2.5	FKM (FPM)
404-040-VS	4		G 1/8	6	8.8	13.5	23.8	12	2.5	NBR
406-158-VS	6		M8×1	6	11.7	13.2	30.5	12	3	NBR
406-004-VS	6		M10×1	6	11.7	13.5	27	12	4	NBR
406-004-S8-VS	6		M10×1	6	11.7	13.5	27	12	4	FKM (FPM)
456-004-VS	6		G 3/8	6	11.7	13.5	27	12	4	NBR
406-054-VS	6		G 1/4	7	11.7	16.4	28	12	4	NBR
406-162-VS	6		M12×1	7	11.7	15.4	28	14	4	NBR
406-162-S8-VS	6		M12×1	7	11.7	15.4	28	14	4	FKM (FPM)
408-004-VS	8		M10×1	6	13.9	15.2	32.3	14	5	NBR
408-004-S8-VS	8		M10×1	6	13.9	15.2	32.3	14	5	FKM (FPM)
408-162-VS	8		M12×1	7	13.9	15.2	32.8	14	6	NBR
408-162-S8-VS	8		M12×1	7	13.9	15.2	32.8	14	6	FKM (FPM)

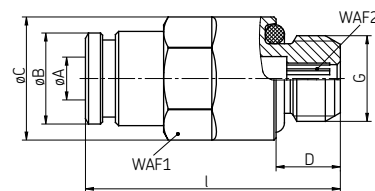

with tapered thread

Order No.	Tube diam.	A	G	D	ø B	ø C	l	WAF1	WAF2
451-004-462-VS	4		M6 tap.	5.5	8.8	11.5	25.8	10	2.5
451-004-498-VS	4		M8×1 tap.	5.5	8.8	11.5	23.3	10	2.5
451-004-518-VS	4		M10×1 tap.	5.5	8.8	11.5	22.8	10	2.5
404-673K-V1-VS	4		1/4-28 SAE LT	5.1	8.8	11.5	26.3	10	2.5
404-040K-V1-VS	4		3/8 NPTF	8	8.8	11.5	24.8	10	2.5
451-006-468-VS	6		M6 tap.	5.5	11.7	13.5	30	12	2.5
451-006-498-VS	6		M8×1 tap.	5.5	11.7	13.5	29.5	12	4
451-006-518-VS	6		M10×1 tap.	5.5	11.7	13.5	27	12	4
406-423W-VS	6		R 3/8 tap.	6.5	11.7	13.5	28.5	12	4

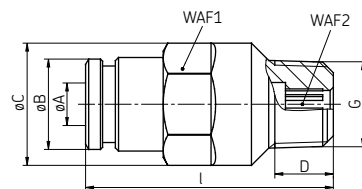

SKF Quick Connectors

For pressures up to 300 bar (metal tube with claw groove)

Elbows, pivoted with cylindrical thread

Order No.	Tube diam. A	G	D	ø B	l1	l2	WAF1	WAF2	Seal
504-101-VS	4	M8×1	6	10	21.8	20.5	10	9	NBR
504-102-VS	4	M10×1	6	10	21.8	20.5	12	9	NBR
504-108-VS	4	G 1/8	6	10	21.8	20.5	12	9	NBR
506-139-VS	6	M8×1	6	12.5	26	21	10	10	NBR
506-140-VS	6	M10×1	6	12.5	26	21	12	10	NBR
506-140-S8-VS	6	M10×1	6	12.5	26	21	12	10	FKM (FPM)
506-108-VS	6	G 1/8	6	12.5	26	21	12	10	NBR
506-142-VS	6	M12×1	7	12.5	26	23	14	10	NBR
506-142-S8-VS	6	M12×1	7	12.5	26	23	14	10	FKM (FPM)
506-143-VS	6	G 1/4	7	12.5	26	23	15	10	NBR
508-142-VS	8	M12×1	7	14.5	28.8	23	14	12	NBR
508-142-S8-VS	8	M12×1	7	14.5	28.8	23	14	12	FKM (FPM)

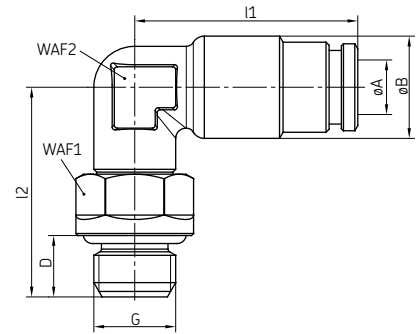

with tapered thread

Order No.	Tube diam. A	G	D	ø B	l1	l2	WAF1	WAF2	Seal
455-546-048-VS	4	M6 tap.	6	10	21.8	20	10	9	NBR
455-546-048-S8-VS	4	M6 tap.	6	10	21.8	20	10	9	FKM (FPM)
455-529-048-VS	4	M8×1 tap.	6	10	21.8	20	10	9	NBR
455-529-048-S8-VS	4	M8×1 tap.	6	10	21.8	20	10	9	FKM (FPM)
455-531-048-VS	4	M10×1 tap.	6	10	21.8	20	12	9	NBR
455-531-048-S8-VS	4	M10×1 tap.	6	10	21.8	20	12	9	FKM (FPM)
455-569-048-VS	4	R 1/8 tap.	7.5	10	21.8	20.5	12	9	NBR
455-529-068-VS	6	M8×1 tap.	6	12.5	26	20	10	10	NBR
455-529-068-S8-VS	6	M8×1 tap.	6	12.5	26	20	10	10	FKM (FPM)
455-531-068-VS	6	M10×1 tap.	6	12.5	26	20.5	12	10	NBR
455-531-068-S8-VS	6	M10×1 tap.	6	12.5	26	20.5	12	10	FKM (FPM)
455-565-068-VS	6	R 1/4 tap.	11	12.5	26	24.5	14	10	NBR

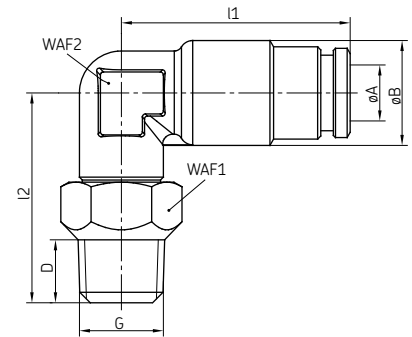

Banjo fittings

Order No.	Tube diam. A	G	D	ø B	l1	l2	WAF1	Seal
504-401-S1-VS	4	M5	5	8.8	21.8	18	8	NBR
504-411-VS	4	M8	7	8.8	23.8	20	12	NBR
504-103-VS	4	M10×1	7	8.8	24.8	22.5	14	NBR
445-519-041-VS	4	G 1/8	7	8.8	24.8	22.5	14	NBR

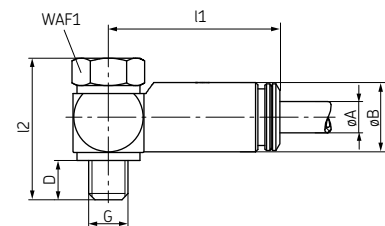

SKF Quick Connectors

For pressures up to 300 bar (metal tube with claw groove)

Elbows with tapered thread

Order No.	Tube diam.	A	G	D	ø B	l1	l2	WAF	Seal
453-004-471-VS	4		M6 tap.	6	10	21.8	14	9	NBR
453-004-471-S8-VS	4		M6 tap.	6	10	21.8	14	9	FPM
504-201-VS	4		M8×1 tap.	6	10	21.8	13.5	9	NBR
504-201-S8-VS	4		M8×1 tap.	6	10	21.8	13.5	9	FPM
504-202-VS	4		M10×1 tap.	6	10	21.8	13.5	9	NBR
504-202-S8-VS	4		M10×1 tap.	6	10	21.8	13.5	9	FPM
514-018-VS	4		R 1/8 tap.	7.5	10	21.8	15	9	NBR
514-018-S8-VS	4		R 1/8 tap.	7.5	10	21.8	15	9	FPM
504-200K-V1-VS	4		1/4-28 SAE LT	5.1	10	21.8	15.5	9	NBR
514-018K-V1-VS	4		1/8 NPTF	7	10	21.8	15	9	NBR
<hr/>									
453-006-468-VS	6		M6 tap.	6	12.5	26	15	10	NBR
453-006-468-S8-VS	6		M6 tap.	6	12.5	26	15	10	FPM
506-508-VS	6		M8×1 tap.	6.5	12.5	26	14	10	NBR
506-508-S8-VS	6		M8×1 tap.	6.5	12.5	26	14	10	FPM
506-510-VS	6		M10×1 tap.	6	12.5	26	14	10	NBR
506-510-S8-VS	6		M10×1 tap.	6	12.5	26	14	10	FPM
506-511-VS	6		R 1/8 tap.	8.5	12.5	26	16.5	10	NBR
506-511-S8-VS	6		R 1/8 tap.	8.5	12.5	26	16.5	10	FPM
506-512-VS	6		M12×1 tap.	7	12.5	26	15	10	NBR
453-006-651-VS	6		R 1/4 tap.	11.5	12.5	26	19.5	10	NBR

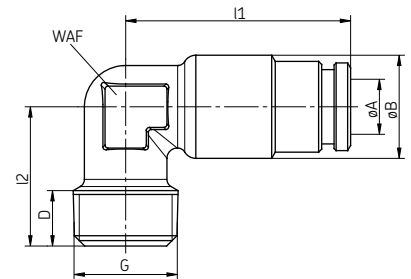

Check valve

Order No.	Tube diam.	Opening pressure [bar]	G
VPKM-RV-VS	6	3 ⁺²	M10×1 tap.
VPKG-RV-VS	6	3 ⁺²	R 1/8 tap.

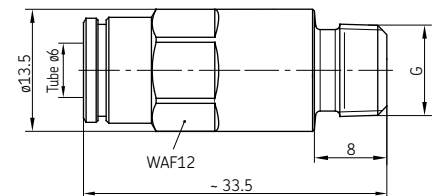

Connector

Order No.	Tube diam.
406-426-VS	6

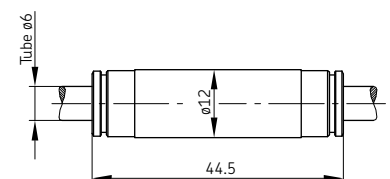

Locking pin

Order No.	Tube diam. d	d1	l1	l2
450-204-002	4	6	31	21
450-206-002	6	8	37	25

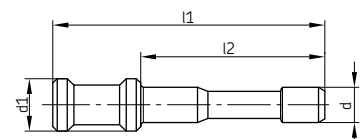

Solderless pipe union with cutting-sleeve acc. to DIN EN ISO 8434-1 and DIN 2353

Cutting sleeves to DIN 3861/ISO 8434-1

Order No.	D (tube diam.)	l	Pressure [bar]
404-301 ¹⁾	4	6	
406-331 ¹⁾	6	7	
96-5708-0058 ¹⁾	8	7	100
96-5710-0058 ¹⁾	10	7	
96-5712-0058 ¹⁾	12	7.5	
406-301	6	9.5	
408-301	8	9.5	500
410-301	10	10	
412-301	12	10	
415-301	15	10	400
418-301	18	10	

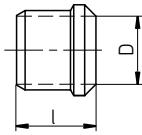

Material: steel, galvanized
surface (Cr-6 free)

Straight connectors (tube to tube)

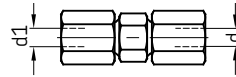

Reducing connectors

Order No.	Tube diam. d. d1	Order No.	Tube diam. d	Tube diam. d1
404-404 ¹⁾	4	504-410	6	4
406-406	6	504-412	8	4
408-408	8	506-410	8	6
410-410	10	506-412	10	6
412-412	12	508-410	10	8
415-415	15	506-413	12	6
418-418	18	508-412	12	8
		510-410	12	10
		508-413	15	8
		510-412	15	10
		512-410	15	12
		510-413	18	10
		512-412	18	12
		515-410	18	15

Union nuts to DIN 3870/ISO 8434-1

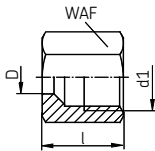

Material: steel,
galvanized surface
(Cr-6 free)

Order No.	D (tube diam.)	d1	l	WAF	Pressure [bar]
404-302 ¹⁾	4	M8×1	11	10	
406-332 ¹⁾	6	M10×1	11.5	14	100
96-5608-0058 ¹⁾	8	M12×1	12	14	
96-5610-0058 ¹⁾	10	M14×1	12.5	17	
406-302	6	M12×1.5	14.5	14	
408-302	8	M14×1.5	14.5	17	500
410-302	10	M16×1.5	15.5	19	
412-302	12	M18×1.5	15.5	22	
96-2815-0058	15	M22×1.5	17	27	400
96-2818-0058	18	M26×1.5	18	32	

Reducing connectors

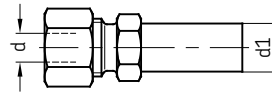

Order No.	Tube diam. d	ø d1
408-406	6	8
410-406	6	10
443-706-121	6	12
443-706-151	6	15
443-706-181	6	18
410-408	8	10
443-708-121	8	12
443-708-151	8	15
443-708-181	8	18
443-710-061	10	8
412-410	10	12
415-410	10	15
443-710-181	10	18
443-712-151	12	15
418-412	12	18
422-412	12	22
443-715-181	15	18

Straight screw-in glands with short threaded end for screwing into thread

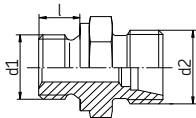

Order No.	Tube diam. d	d1	d2	l
406-323	6	M10×1 tap.	M10×1	–
408-313	8	M14×1.5	M14×1.5	9
410-313	10	M16×1.5	M16×1.5	9
410-323	10	M14×1.5	M16×1.5	9

The cutting sleeve screw unions shown correspond to the L-series (light version).

¹⁾ LL-series (extra light version)

Solderless pipe union with cutting-sleeve acc. to DIN EN ISO 8434-1 and DIN 2353

Straight screw-in connectors to DIN 2353

with metrical thread

Order No.	Tube diam. d	d1	Series
406-403	6	M10×1	
96-0308-0058	8	M12×1	
410-403	10	M14×1.5	
410-463	10	M18×1.5	
412-423	12	M14×1.5	
412-403	12	M16×1.5	
412-433	12	M18×1.5	
415-403	15	M18×1.5	L
415-413	15	M22×1.5	
418-403	18	M22×1.5	
96-0319-0058	18	M18×1.5	
96-0321-0058	22	M22×1.5	
96-0322-0058	22	M26×1.5	
96-0328-0058	28	M33×2	
96-0335-0058	35	M42×2	
96-0342-0058	42	M48×2	
<hr/>			
96-1206-0058	6	M12×1.5	
406-413	6	M14×1.5	
408-413	8	M14×1.5	
410-413	10	M16×1.5	S
412-453	12	M18×1.5	
96-1212-0058	12	M18×1.5	
96-1214-0058	14	M20×1.5	
96-1216-0058	16	M22×1.5	
96-1220-0058	20	M27×1.5	
<hr/>			
24-2105-2373	2.5	M6 tap.	
96-6002-0058	4	M6×1 tap.	
404-413	4	M8×1 tap.	
404-403	4	M10×1 tap.	
406-423	6	M10×1 tap.	
406-443	6	M6 tap.	LL
406-433	6	M8×1 tap.	
406-423	6	M10×1 tap.	
441-008-511	8	M10×1 tap.	
24-2105-2381	10	M10×1 tap.	
410-443	10	M10×1 tap.	L

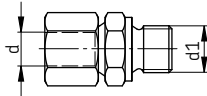

Straight screw-in connectors to DIN 2353

with Whitworth pipe thread

Order No.	Tube diam. d	d1	Series
44-2573-6330	4	G 1/4 A	
406-403W	6	G 1/8 A	
96-0204-0058	6	G 1/4 A	
406-463W	6	G 3/8 A	
96-0203-0058	8	G 1/8 A	
408-403W	8	G 1/4 A	
408-413W	8	G 3/8 A	
408-453W	8	G 1/2 A	
410-403W	10	G 1/4 A	
410-413W	10	G 3/8 A	
410-433W	10	G 1/2 A	
412-423W	12	G 1/4 A	L
412-403W	12	G 3/8 A	
412-453W	12	G 1/2 A	
415-443W	15	G 3/4 A	
415-403W	15	G 1/2 A	
415-433W	15	G 3/8 A	
418-403W	18	G 1/2 A	
418-413W	18	G 3/4 A	
96-0223-0058	22	G 1/2 A	
96-0222-0058	22	G 3/4 A	
428-413W	28	G 3/4 A	
96-0228-0058	28	G 1 A	
<hr/>			
96-1106-0058	6	G 1/4 A	
96-1108-0058	8	G 1/4 A	
96-1109-0058	8	G 3/8 A	
96-1111-0058	10	G 1/4 A	
96-1110-0058	10	G 3/8 A	
96-1112-0058	12	G 3/8 A	S
96-1113-0058	12	G 1/2 A	
96-1114-0058	14	G 1/2 A	
96-1117-0058	16	G 3/8 A	
96-1116-0058	16	G 1/2 A	
96-1121-0058	20	G 1/2 A	
96-1120-0058	20	G 3/4 A	
<hr/>			
404-403W	4	R 1/8 tap.	
406-423W	6	R 1/8 tap.	
408-423W	8	R 1/8 tap.	
96-5909-0058	8	R 1/4 tap.	LL
96-5911-0058	10	G 1/4 tap.	
24-2105-2382	10	G 1/8 tap.	
96-5912-0058	11	G 1/8 tap.	
96-5913-0058	12	G 3/8 tap.	

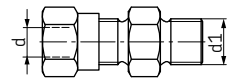

L-screw-in connectors directionally adjustable

Order No.	Tube diam. d	d1	Series
443-406-061	6	M12×1.5	
443-408-081	8	M14×1.5	
443-410-101	10	M16×1.5	L
443-412-121	12	M18×1.5	
443-415-151	15	M22×1.5	
443-418-181	18	M26×1.5	
<hr/>			
443-406-351	6	M14×1.5	
443-408-083	8	M16×1.5	
96-3010-0060	10	M18×1.5	S
96-3012-0060	12	M20×1.5	
96-3014-0060	14	M22×1.5	
96-3016-0060	16	M24×1.5	
<hr/>			
443-410-211	10	G 3/8 A	S
<hr/>			
443-406-691	6	G 1/8 A	L
443-410-161	10	G 3/4 A	

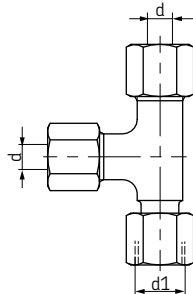

Straight bulkhead connectors

Order No.	Tube diam. d	ø d1
406-416	6	12.5
408-416	8	14.5
410-416	10	16.5
412-416	12	18.5
415-416	15	22.5
418-416	18	26.5
422-416	22	30.5

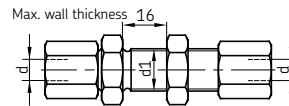

LL-series (extra light version)
L-series (light version)
S-series (heavy duty version)

Solderless pipe union with cutting-sleeve acc. to DIN EN ISO 8434-1 and DIN 2353

Elbow bulkhead connectors

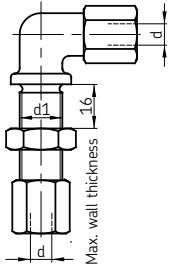

Order No.	Tube diam. d	ø d1
406-409	6	12.5
408-409	8	14.5
410-409	10	16.5
412-409	12	18.5
415-409	15	22.5
418-409	18	26.5
443-190-901	22	30.5

Elbow connectors

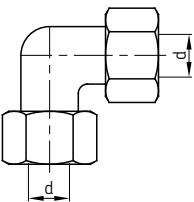

Order No.	Tube diam. d
406-404	6
96-0408-0058	8
410-404	10
412-404	12
443-215-001	15
443-218-001	18
443-290-001	22

Elbow screw-in connectors

Order No.	Tube diam. d	d1	Series
96-6202-0058	4	M6 tap.	
96-6204-0058	4	M8x1 tap.	
404-425	4	M10x1 tap.	
406-445	6	M6 tap.	LL
406-435	6	M8x1 tap.	
406-425	6	M10x1 tap.	
408-425	8	M10x1 tap.	
406-405	6	M10x1 tap.	
408-405	8	M12x1.5 tap.	
410-405	10	M14x1.5 tap.	L
412-405	12	M16x1.5 tap.	
415-405	15	M18x1.5 tap.	
410-425	10	M16x1.5 tap.	S
404-405W	4	R 1/8 tap.	
96-6106-0058	6	R 1/8 tap.	
96-6108-0058	8	R 1/8 tap.	LL
96-6110-0058	10	R 1/4 tap.	
96-6112-0058	12	R 1/4 tap.	
406-405W	6	R 1/8 tap.	
406-515W	6	R 1/4 tap.	
408-425W	8	R 1/8 tap.	
408-405W	8	R 1/4 tap.	L
410-405W	10	R 1/4 tap.	
412-405W	12	R 3/8 tap.	
415-405W	15	R 1/2 tap.	
418-405W	18	R 1/2 tap.	
96-1406-0058	6	R 1/4 tap.	
96-1408-0058	8	R 1/4 tap.	
96-1410-0058	10	R 3/8 tap.	S
96-1412-0058	12	R 3/8 tap.	
96-1414-0058	14	R 1/2 tap.	
96-1416-0058	16	R 1/2 tap.	

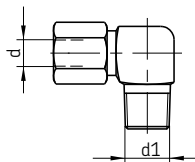

Banjo fittings

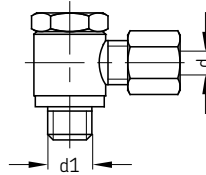

Order No.	Tube diam. d	d1	Series
445-529-041	4	M8x1	LL
445-531-061	6	M10x1	
96-7808-0058	8	M12x1.5	
445-535-101	10	M14x1.5	
96-7812-0058	12	M16x1.5	L
96-7815-0058	15	M18x1.5	
96-7818-0058	18	M22x1.5	
96-7822-0058	22	M26x1.5	
96-8006-0058	6	M12x1.5	
96-8008-0058	8	M14x1.5	
96-8010-0058	10	M16x1.5	
96-8012-0058	12	M18x1.5	S
96-8014-0058	14	M20x1.5	
96-8016-0058	16	M22x1.5	
96-8020-0058	20	M27x1.5	
96-7106-0058	6	M10x1	LL
96-7108-0058	8	M10x1	
96-7004-0058	4	G 1/8 A	LL
445-519-041	4	G 1/8 A	
445-519-061	6	G 1/8 A	
445-516-061	6	G 1/4 A	
445-516-081	8	G 1/4 A	L
445-516-101	10	G 1/4 A	
445-521-122	12	G 3/8 A	
445-513-181	18	G 1/2 A	
445-517-222	22	G 3/4 A	
96-7906-0058	6	G 1/4 A	
96-7908-0058	8	G 1/4 A	
96-7910-0058	10	G 3/8 A	
96-7912-0058	12	G 3/8 A	S
96-7914-0058	14	G 1/2 A	
96-7916-0058	16	G 1/2 A	
96-7920-0058	20	G 3/4 A	
96-7006-0058	6	G 1/8 A	LL
96-7008-0058	8	G 1/8 A	

LL-series (extra light version)
L-series (light version)
S-series (heavy duty version)

Solderless pipe union with cutting-sleeve acc. to DIN EN ISO 8434-1 and DIN 2353

Connectors for pressure gauges

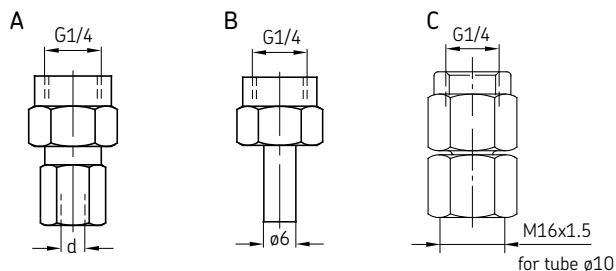

L = light version

S = heavy duty version

Tube ø d	Order No.	Version	Tube ø d	Order No.	Version
4	96-8804-0058	C	6	96-0406-0060	A
6	406-411	A	6	96-8906-0058	C
6	248-610.01	B	8	96-0408-0060	A
6	441-106-162	C	8	96-8908-0058	C
8	408-411	A	10	96-0410-0060	A
8	441-108-162	C	10	96-8910-0058	C
10	410-411	A	12	96-0412-0060	A
10	441-110-163	C	12	96-8912-0058	C
12	412-411	A			
12	441-112-162	C			

Tee screw-in connectors

Order No.	Tube diam. d	d1	Series
96-6404-0058	4	M8x1 tap.	
96-6406-0058	6	M10x1 tap.	LL
96-6408-0058	8	M10x1 tap.	

96-0906-0058	6	M10x1 tap.	
96-0908-0058	8	M12x1.5 tap.	
445-910-551	10	M14x1.5 tap.	L
96-0912-0058	12	M16x1.5 tap.	
96-0915-0058	15	M18x1.5 tap.	

96-1806-0058	6	M12x1.5 tap.	
96-1808-0058	8	M14x1.5 tap.	
96-1810-0058	10	M16x1.5 tap.	S
96-1812-0058	12	M18x1.5 tap.	
96-1814-0058	14	M20x1.5 tap.	
96-1816-0058	16	M22x1.5 tap.	

96-6304-0058	4	R 1/8 tap.	
96-6306-0058	6	R 1/8 tap.	LL
96-6308-0058	8	R 1/8 tap.	

96-0806-0058	6	R 1/8 tap.	
96-0808-0058	8	R 1/4 tap.	
96-0810-0058	10	R 1/4 tap.	L
96-0812-0058	12	R 3/8 tap.	
96-0815-0058	15	R 1/2 tap.	
96-0818-0058	18	R 1/2 tap.	

96-1706-0058	6	R 1/4 tap.	
96-1708-0058	8	R 1/4 tap.	
96-1710-0058	10	R 3/8 tap.	S
96-1712-0058	12	R 3/8 tap.	
96-1714-0058	14	R 1/2 tap.	
96-1716-0058	16	R 1/2 tap.	

445-721-121	12	G 3/8 A	
445-713-151	15	G 1/2 A	L
445-717-221	22	G 3/4 A	

445-735-101	10	M14x1.5	L
445-739-151	15	M18x1.5	

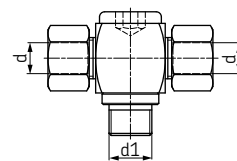

Four-way connectors

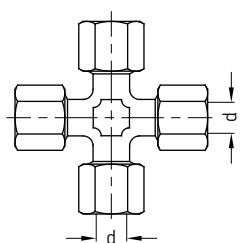

Order No.	Tube diam. d
96-2106-0058	6
446-308-001	8
446-310-001	10
446-312-001	12
446-315-001	15
96-2118-0058	18
96-2122-0058	22

Tee connectors

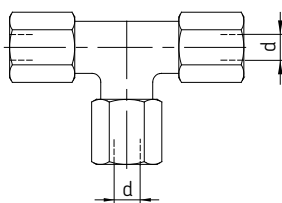

Order No.	Tube diam. d
96-6904-0058 ¹⁾	4
406-407	6
408-407	8
410-407	10
412-407	12
415-407	15
418-407	18
422-407	22

Tee screw-in connectors

directionally adjustable

Order No.	Tube diam. d	d1	Series
96-3106-0060	6	M12x1.5	
444-808-351	8	M14x1.5	
445-810-371	10	M16x1.5	L
96-3112-0060	12	M18x1.5	
96-3115-0060	15	M22x1.5	
96-3118-0060	18	M26x1.5	
96-3122-0060	22	M30x1.5	

445-806-351	6	M14x1.5	
96-3208-0060	8	M16x1.5	
96-3210-0060	10	M18x1.5	
96-3212-0060	12	M20x1.5	S
96-3214-0060	14	M22x1.5	
96-3216-0060	16	M24x1.5	
96-3220-0060	20	M30x1.5	

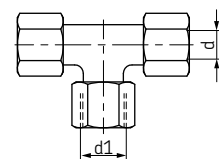

LL-series (extra light version)
L-series (light version)
S-series (heavy duty version)

Solderless pipe union with cutting-sleeve acc. to DIN EN ISO 8434-1 and DIN 2353

Reducing connections

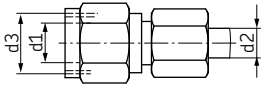

Order No.	Tube diam. d1	Tube diam. d2	d3	Series
96-1406-0060	6	4	M10×1	LL
96-1408-0060	8	4	M12×1	
96-1410-0060	8	6	M12×1	
96-1508-0060	8	6	M14×1.5	L
96-1511-0060	10	6	M16×1.5	
96-1512-0060	10	8	M16×1.5	
96-1521-0060	12	6	M18×1.5	
96-1522-0060	12	8	M18×1.5	
96-1523-0060	12	10	M18×1.5	
96-1531-0060	15	6	M22×1.5	
96-1532-0060	15	8	M22×1.5	
96-1533-0060	15	10	M22×1.5	
96-1534-0060	15	12	M22×1.5	
96-1541-0060	18	6	M26×1.5	
96-1542-0060	18	8	M26×1.5	
96-1543-0060	18	10	M26×1.5	
96-1544-0060	18	12	M26×1.5	
96-1545-0060	18	15	M26×1.5	
96-1551-0060	22	6	M30×2	
96-1552-0060	22	8	M30×2	
96-1553-0060	22	10	M30×2	
96-1554-0060	22	12	M30×2	
96-1555-0060	22	15	M30×2	
96-1556-0060	22	18	M30×2	
96-1610-0060	8	6	M16×1.5	S
96-1611-0060	10	6	M18×1.5	
96-1612-0060	10	8	M18×1.5	
96-1621-0060	12	6	M20×1.5	
96-1622-0060	12	8	M20×1.5	
96-1623-0060	12	10	M20×1.5	
96-1631-0060	14	6	M22×1.5	
96-1632-0060	14	8	M22×1.5	
96-1633-0060	14	10	M22×1.5	
96-1634-0060	14	12	M22×1.5	
96-1641-0060	16	6	M24×1.5	
96-1642-0060	16	8	M24×1.5	
96-1643-0060	16	10	M24×1.5	
96-1644-0060	16	12	M24×1.5	
96-1645-0060	16	14	M24×1.5	
96-1651-0060	20	6	M30×2	
96-1652-0060	20	8	M30×2	
96-1653-0060	20	10	M30×2	
96-1654-0060	20	12	M30×2	
96-1655-0060	20	14	M30×2	
96-1656-0060	20	16	M30×2	

LL-series (extra light version)
L-series (light version)
S-series (heavy duty version)

Reducing connections Sealing by sealing edge

Order No.	d1	Tube diam. d2	l1
96-3114-0058	G 1/8 A	G 1/4	31
96-3115-0058	G 1/8 A	G 3/8	32
96-3116-0058	G 1/4 A	G 1/8	28
96-3117-0058	G 1/4 A	G 3/8 A	36
96-3118-0058	G 1/4 A	G 1/2	40
96-3119-0058	G 1/4 A	G 3/4	43
96-3101-0058	G 3/8 A	G 1/8	22.5
96-3120-0058	G 3/8 A	G 1/4	36
96-3121-0058	G 3/8 A	G 1/2	41
96-3122-0058	G 3/8 A	G 3/4	44
96-3102-0058	G 1/2 A	G 1/8	24
96-3103-0058	G 1/2 A	G 1/4	24
96-3123-0058	G 1/2 A	G 3/8	36
96-3124-0058	G 1/2 A	G 3/4	46
96-3125-0058	G 1/2 A	G 1	49
96-3126-0058	G 1/2 A	G 1 1/4	53
96-3104-0058	G 3/4 A	G 1/4	26
96-3105-0058	G 3/4 A	G 3/8	26
96-3127-0058	G 3/4 A	G 1/2	41
96-3128-0058	G 3/4 A	G 1	51
96-3129-0058	G 3/4 A	G 1 1/4	55
96-3130-0058	G 3/4 A	G 1 1/2	57
96-3106-0058	G 1 A	G 1/4	29
96-3107-0058	G 1 A	G 3/8	29
96-3108-0058	G 1 A	G 1/2	29
96-3131-0058	G 1 A	G 3/4	47
96-3132-0058	G 1 A	G 1 1/4	57
96-3133-0058	G 1 A	G 1 1/2	59
96-3109-0058	G 1 1/4 A	G 1/2	32
96-3110-0058	G 1 1/4 A	G 3/4	32
96-3134-0058	G 1 1/4 A	G 1	52
96-3135-0058	G 1 1/4 A	G 1 1/2	60
96-3111-0058	G 1 1/2 A	G 1/2	36
96-3112-0058	G 1 1/2 A	G 3/4	36
96-3113-0058	G 1 1/2 A	G 1	36
96-3136-0058	G 1 1/2 A	G 1 1/4	58
96-3137-0058	G 2 A	G 1 1/2	62

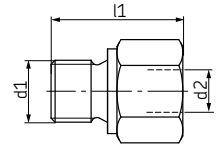

Straight screw-in fitting

Order No.	Tube diam. d1	d3	Series
96-0506-0060	6	M10×1	L
96-0508-0060	8	M12×1.5	
96-0510-0060	10	M14×1.5	
96-0512-0060	12	M16×1.5	
96-0515-0060	15	M18×1.5	
96-0518-0060	18	M22×1.5	
96-0522-0060	22	M26×1.5	
96-0606-0060	6	M12×1.5	S
96-0608-0060	8	M14×1.5	
96-0610-0060	10	M16×1.5	
96-0612-0060	12	M18×1.5	
96-0614-0060	14	M20×1.5	
96-0616-0060	16	M22×1.5	
96-0620-0060	20	M27×2	
96-0706-0060	6	G 1/8 A	L
96-0708-0060	8	G 1/4 A	
96-0709-0060	8	G 3/8 A	
96-0710-0060	10	G 1/4 A	
96-0711-0060	10	G 3/8 A	
96-0712-0060	12	G 3/8 A	
96-0713-0060	12	G 1/2 A	
96-0715-0060	15	G 1/2 A	
96-0718-0060	18	G 1/2 A	
96-0722-0060	22	G 3/4 A	

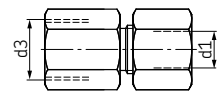

Solderless pipe union with cutting-sleeve acc. to DIN EN ISO 8434-1 and DIN 2353

Straight screw-in connectors with Eolastic washer and E02 function nut

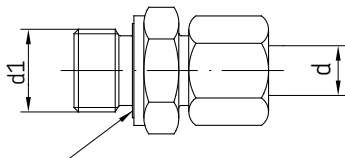

EOLASTIC washer

Order No.	Tube diam. d	d1
471-004-191 ¹⁾ 471-004-311 ¹⁾	4	G 1/8 A M10x1
471-006-192 471-006-161 471-006-311 471-006-351	6	G 1/8 A G 1/4 A M10x1 M14x1.5
471-008-161 471-008-211 471-008-351 471-008-391	8	G 1/4 A G 3/8 A M14x1.5 M18x1.5
471-010-161 471-010-211 471-010-312 471-010-351 471-010-391	10	G 1/4 A G 3/8 A M10x1 M14x1.5 M18x1.5
471-012-161 471-012-211 471-012-391	12	G 1/4 A G 3/8 A M18x1.5
471-015-131	15	G 1/2 A

¹⁾ LL-series (extra light version)

Straight connectors (tube to tube) with E02 function nut

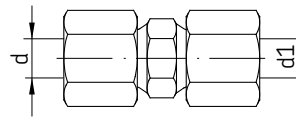

Order No.	Tube diam. d, d1
474-506-061	6
474-508-081	8
474-510-101	10
474-512-121	12
474-515-151	15
474-518-181	18

Tee connectors with E02 function nut

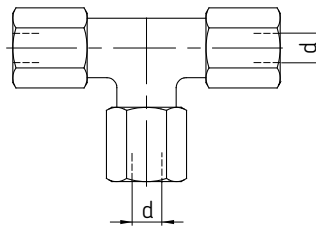

Order No.	Tube diam. d
476-006-001	6
476-008-001	8
476-010-001	10
476-012-001	12
476-015-001	15

Straight bulkhead connectors with E02 function nut

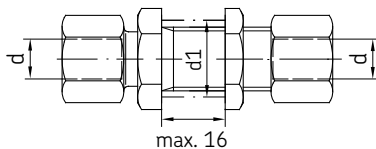

Order No.	Tube diam. d	d1
474-606-331	6	12.5
474-608-351	8	14.5
474-610-351	10	16.5
474-612-391	12	18.5
474-615-431	15	22.5
474-618-441	18	26.5

Max. operating pressure 315 bars

Connectors for pressure gauges with E02 function nut

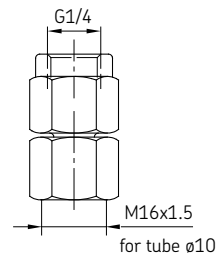

Order No.	Tube diam. d
441-106-163	6
471-108-163	8
471-110-163	10
471-112-163	12

Solderless pipe union with cutting-sleeve acc. to DIN EN ISO 8434-1 and DIN 2353

Reducing connectors with E02 function nut

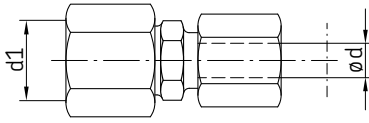

Order No.	Tube diam. d	d1
473-806-351	6	M14×1.5
473-806-391	6	M20×1.5
473-808-371	8	M16×1.5
473-808-392	8	
473-810-391	10	M18×1.5
473-810-371	10	

Screw plugs

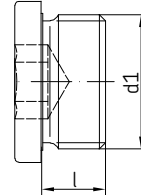

Order No.	d1	l
466-411-001	G 1 A	16
466-413-001	G 1/2 A	14
466-416-001	G 3/4 A	12
466-418-001	G 3/4 A	16
466-419-001	G 1/8 A	7
466-431-001	M10×1	7
466-435-003	M14×1.5	11
466-439-001	M18×1.5	12

Cone plug

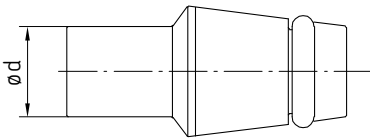

Order No.	Tube diam. d
460-706-001	6
460-708-001	8
460-710-001	10
460-712-001	12

Vent plug

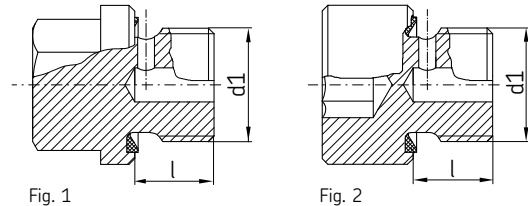

Order No.	d1	l	Figure
466-431-006	M10×1	7	1
466-431-005	M10×1	7	2
466-431-009	G 1/8	7	2

Accessories

Fixing bolts

Order No	d1	l	d2	Material
DIN84-M3×5-4.8	M3	5	5.5	steel
DIN84-M5×8-4.8	M5	8	8.5	
DIN84-M5×16-4.8	M5	16	8.5	
DIN84-M5×20-4.8	M5	20	8.5	
DIN84-M6×16-4.8	M6	16	10	
DIN84-M6×20-4.8	M6	20	10	
DIN84-M6×25-4.8	M6	25	10	

DIN84

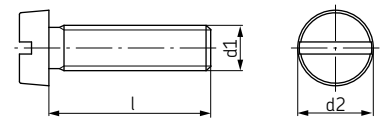

Order No.	d1	l	d2	b	WAF	Material
DIN912-M4×20-8.8	M4	20	7	14	3	steel
DIN912-M6×16-8.8	M6	16	10	18	5	
DIN912-M6×25-8.8	M6	25	10	18	5	
DIN912-M6×60-8.8	M6	60	10	18	5	
DIN912-M8×16-8.8	M8	16	13	12	6	

DIN912

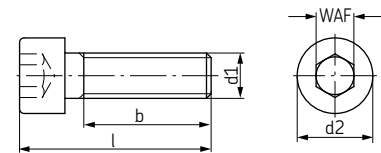

Order No.	d1	l	b	WAF	Material
DIN931-M6×30-5.8	M6	30	18	10	steel

DIN931

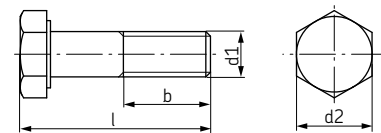

Order No.	d1	l	d2	Material
DIN7513-BM4×20	M4	20	7	steel
DIN7513-BM4×25	M4	25	7	
DIN7513-BM5×10	M5	10	8.5	
DIN7513-BM6×16	M6	16	10	
DIN7513-BM6×25	M6	25	10	

DIN7513

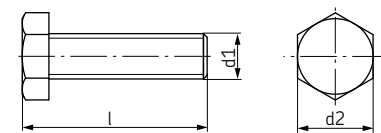

Nuts

Order No.	Thread	m	WAF	e	Material
DIN934-M5-8	M5	4	8	9.2	steel
DIN934-M6-8	M6	5	10	11.5	
DIN936-M14×1.5-5	M14×1.5	8	22	25.4	
DIN936-M16×1.5-5	M16×1.5	8	24	27.7	
DIN936-M20×1.5-5	M20×1.5	9	30	34.6	

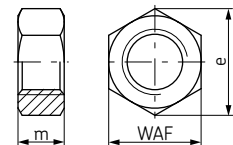

Lock washer

Order No.	for bolt	d1	d2	s	h	Material
650-050	M5	5.3	9	0.6	0.9	spring steel
650-060	M6	6.4	10	0.7	0.9	
650-080	M8	8.4	13	0.8	1.2	
650-100	M10	10.5	16	1	1.5	
650-120	M12	13	18	1.1	1.5	
650-140	M14	15	22	1.2	1.8	
650-160	M16	17	24	1.3	1.9	
650-180	M18	19	27	1.5	2.2	
650-200	M20	21	30	1.5	2.2	

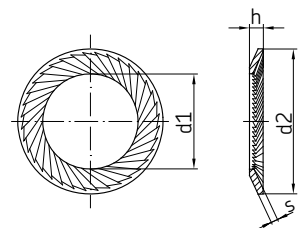

Accessories

Fixing clips

Order No.	for tube diam. ø D	b	d	l1	l2	s
602-001	2.5	10	3.5	11.25	5	1.5
604-001	4	10	5.5	18.5	9	1.5
606-010	6	10	5.5	20.5	10	1.5
608-001	8	10	5.5	23.5	12	1.5
610-001	10 or 1 1/8"	10	5.5	25.5	13	1.5
612-001	12	20	6.8	35	18	2

Order No.	for tube diam. ø D	for tube diam.	b	d	l1	l2	s
602-002	2.5	2		3.5	13.8	5	
604-002	4	2	10	5.5	22.6	9	1.5
604-003	4	3		5.5	26.6	9	

Order No.	for tube diam. ø D	b	d	l1	l2	s
608-003	8 / 4	10	5.5	34	12	1.5

Order No.	for tube diam. or socket diam. of tee ø D	b	c	d	l1	l2	s
604-004	12	24	14	5.5	27	13	1.5
606-014	14 or 1/4"	30	15	6.3	32.5	16	2
608-004	18 or 3/8"	36	20	7	40	21	2
610-004	20 or 1/2"	36	20	7	40	21	2

Order No.	ø D	for tube diam. diam.	for tube b d	l1	l2	s	Material
604-014	4	4	5.5	42	30	1.5	
604-015	4	5	5.5	46	34	1.5	
604-016	4	6	5.5	50	38	1.5	
604-018	4	8	5.5	58	46	1.5	
DIN 72573-2×6-ST	6	2	4.8	39	27	1	
DIN 72573-3×6-ST	6	3	4.8	45	33	1	
DIN 72573-4×6-ST	6	4	4.8	51	39	1	
DIN 72573-5×6-ST	6	5	4.8	57	45	1	
DIN 72573-6×6-ST	6	6	4.8	64	52	1	mild steel
DIN 72573-2×8-ST	8	2	4.8	43	31	1	
DIN 72573-3×8-ST	8	3	4.8	51	39	1	
DIN 72573-4×8-ST	8	4	4.8	59	47	1	
DIN 72573-5×8-ST	8	5	4.8	68	56	1	
DIN 72573-6×8-ST	8	6	4.8	76	64	1	
DIN 72573-2×10-ST	10	2	4.8	45	33	1	
DIN 72573-3×10-ST	10	3	4.8	55	43	1	
DIN 72573-4×10-ST	10	4	4.8	67	55	1	
DIN 72573-5×10-ST	10	5	4.8	77	65	1	

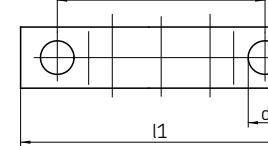
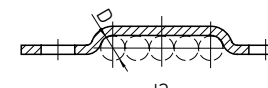
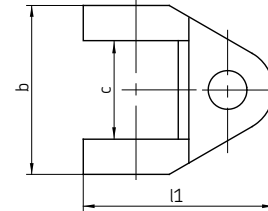
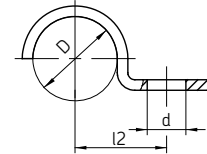
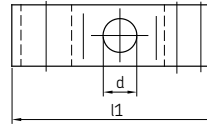
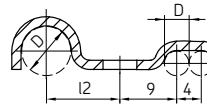
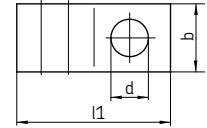
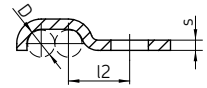
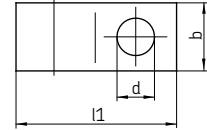
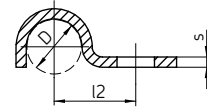

Accessories

Steel tubing

Order No.	$\varnothing da$ ± 0.05	s ± 0.03	Minimum bending radius r bent with mandrel	Minimum bending radius r bent with grooved disk	Design pressure [bar]	Burst pressure [bar]
WV-R02.5x0.5 VERKU	2.5	0.5	5	–	580	1410
WV-R04x0.7 VERZI	4	0.7	8	7	500	1220
WV-R06x0.7 VERZI	6	0.7	25	12	320	850
WV-R08x0.7 VERZI	8	0.7	46	19	230	675
WV-R08x1 VERZI	8	1	46	19	340	840
WV-R010x0.7 VERZI	10 *)	0.7	76	27	180	550

*) $\varnothing da \pm 0.07$ VERKU = copper-plated
VERZI = 25 μm alvanization – Cr3 thick-film passivated. Length delivered 5 m. Stainless steel tubing on request.

EN10305-4, Cr-6 free

Order No.	$\varnothing da$ ± 0.08	s	Minimum bending radius r with manual bending device ¹⁾	Minimum bending radius r with electrical bending device
982-120-040	4	1	–	10
982-120-060	6	1	16	9
982-120-080	8	1	22	12
982-120-100	10	1	27	15
982-120-120	12	1.5	29	18
982-120-150	15	1.5	–	22.5
982-120-180	18	1.5	–	36

Seamless cold-drawn tube for hydraulic and delivery lines according to EN10305-4

¹⁾ Tube bending device, order No. 248-803.20

Material properties:

- galvanic zinc coating (blue-white) on the outside
- thick-film passivated
- deposit thickness 9-12 μm
- Cr6 free

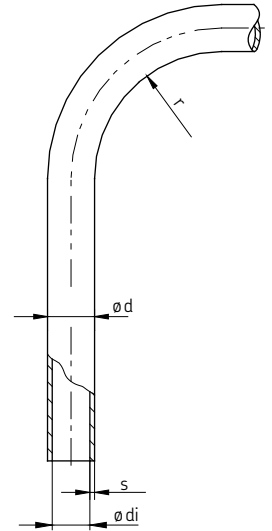

Tube bending device

This device contains all parts needed to bend tubes with a 4, 6, 8 and 10 mm outside diameter. Thin-walled steel tubes with a 10 mm outside diam. may be slightly flattened at the outer bend, but that is not essential with regard to strength or reduction of cross section.

Inner bending radius tube 4 mm outside tube diam.: 10 mm
tube 6 mm outside tube diam.: 16 mm
tube 8 mm outside tube diam.: 22 mm
tube 10 mm outside tube diam.: 27 mm

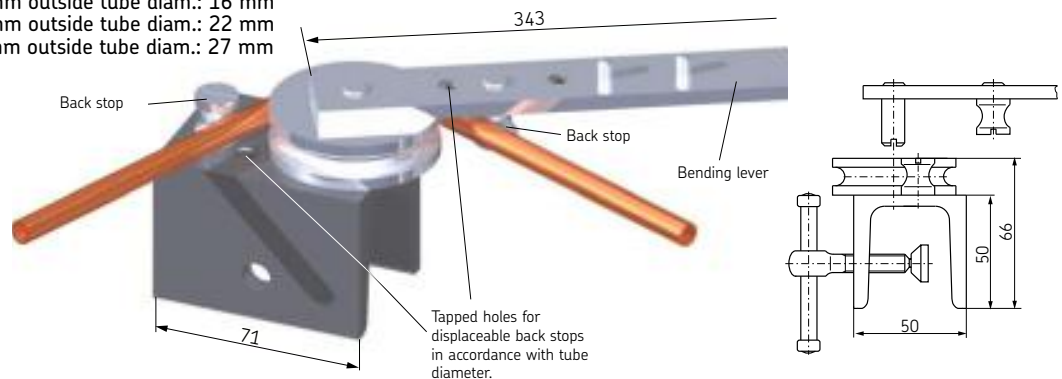

Order No. 248-803.20

There is a special grooved disk for the bending tube with 12 mm o.d, order No. 248-803.17

For older bending devices a retrofitting set for the bending tube with 4 mm is available, order No. 248-803.16

Accessories

Plastic tubing

WVN715, without plasticizer WVN716, flexible (containing plasticizer)

Order No. ¹⁾	ø da	s	ø di ^{+0.15 -0.05}	Smallest permissible bending radius r bent		Perm. operating press. ³⁾ [bar]	Burst press. [bar]
				freehand	with fixture ²⁾		
WVN715-R02.5x0.5	2.5	0.5	1.5	25	9	66	198
WVN715-R04x0.85	4	0.85	2.3	38	14	72	216
WVN715-R06x1	6 ±0.1	1	4	63	21	53	159
WVN715-R06x1.25	6	1.25	3.5	63	21	70	210
WVN715-R08x1.25	8	1.25	5.5	76	28	49	147
WVN715-R010x1.5	10	1.5	7	89	35	47	141
WVN715-R012x1	12 ±0.15	1	10	110	45	24	72
WVN715-R012x1.5	12	1.5	9	110	45	38	114
WVN716-R04x0.85	4	0.85	2.3	38	14	36	108
WVN716-R06x1.25	6 ±0.1	1.25	3.5	63	21	35	105
WVN716-R08x1.25	8	1.25	5.5	80	30	25	75

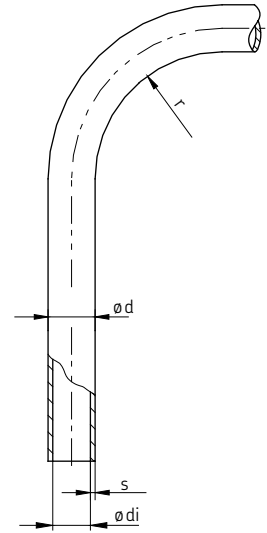

Color: natural colors, black lettering. Tubing available in green, red, black or brown on request.
Tubing with other dimensions or also filled with NLGI grade 2 grease or fluid grease on request.

Important note: For screwed tubing joints only use unions with reinforcing sockets!

Material WVN715: PA 12 H: polyamide 12, semirigid, unplasticized as per DIN 73378, stabilized against heat and aging.
(black tubing) PA 12 HL: polyamide 12, semirigid, unplasticized as per DIN 73378, stabilized against light, heat, and aging.

Material WVN716: PA 12 PH: polyamide 12, flexible, semirigid, unplasticized as per DIN 73378, stabilized against heat and aging.
(black tubing) PA 12 PHL: polyamide 12, flexible, unplasticized as per DIN 73378, stabilized against light, heat, and aging.

Material properties:

- very good resistance and insensitivity to oils, greases, lubricants, all fuels, chlorinefree detergents and solvents.
- At room temperature good resistance to diluted mineral acids, organic acids, bases and saline solutions ⁴⁾
- inappropriate for concentrated mineral acids, concentrated acetic acid, phenols, cresols, chlorinated hydrocarbons, chlorine, acetones and ketones.

Permissible operating temperature: approx. -60 °C to +80 °C

¹⁾ The desired length. e.g. 50 meters, has to be added to the order No. **Order example: WVN716R06x1.25x50M**

²⁾ These minimal radii can be produced with the help of appropriate bending devices.
The tubing has to be heated to 150 °C for this purpose. The maximum duration of heating is 20 seconds.

³⁾ The operating pressures were determined by using DIN 73 378 acc. to the formula $P = \frac{20 \cdot \sigma_V \cdot s \cdot (rated)}{dm}$.

s = rated wall thickness [mm];
dm = da - s;
 σ_V = reference tension N/mm² at 23 °C

At higher temperatures the pressure drops in keeping with the pressure efficiency as per DIN 73378.

Temperature ra [°C]	Pressure efficiency [%]
up to 30	83
up to 40	72
up to 50	64
up to 60	57
up to 70	52
up to 80	47

⁴⁾ In borderline cases it is advisable to contact SKF Lubrication Systems.

Accessories

Hoses

for main lines, operating pressure: 45 bars (for short time only)

Standard		Metalbraided				Tube diam. d1	Thread d3	Rubber d2	Metal-braided d4	Max. increase in volume at ≈ 80 bars [cm ³ /m]
Order No. ²⁾	Order No.	Order No. ²⁾	Order No.	Order No.						
714-...(-VS)	714-...-K	714-...-M(-VS)	714-...-MK	4	M8x1	11	12 \pm 0.5	2.5		
716-...(-VS)	716-...-K	716-...-M(-VS)	716-...-MK	6	M10x1	13	14 \pm 0.8	3.6		
718-...(-VS)	718-...-K	718-...-M(-VS)	718-...-MK	8	M14x1.5	15	16 \pm 0.8	4.4		

Material: Hose: mineraloilresistant CR rubber inside; 2 layers of braided rayon; outside rubber conditionally oilresistant, resistant to light cracks and ozone.
Metal braid: galvanized steel wire; tube ends: galvanized steel tubing.

for secondary lines, operating pressure 15 bars (for short time only)

Standard		Tube diam. d1	Thread d3	Rubber d2
Order No.	Order No.			
734-... ³⁾	734-...-VS ³⁾	4	M8x1	8.8

Material: Hose: oilproof rubber inside and outside with a layer of braided rayon
Tube ends: steel tubing
The ends of the tubing are bonded to the hose and cannot be detached.

Permissible operating temperature: -30 °C to +70 °C

¹⁾ Order length in mm; other lengths available. Standardized lengths ± 5 mm with $\varnothing 4$ tubing: 180, 220, 260, 300, 380, 420, 450, 500, 580
with $\varnothing 6$ tubing: 220, 300, 340, 380, 420, 500, 580
with $\varnothing 8$ tubing: 340, 450, 580

Order examples:

Standard with socket unions and tapered sleeves, $\varnothing 4$ tubing, 300 mm lang, order No.: 714-300-K
Standard, $\varnothing 4$ tubing with claw groove for quick connectors, 300 mm long, order No.: 714-300-VS
Metal-braided, $\varnothing 6$ tubing, 420 mm lng, order No.: 716-420-M
Metal-braided, $\varnothing 8$ tubing, with claw groove for quick connectors, 450 mm long, order No.: 718-450-M-VS

²⁾ For Version with claw groove on ends of tubing for quick connectors, order No.: ...-VS

³⁾ **Important note:** To avoid damages do not use these hoses as main lines but only to connect distributors to lube points.

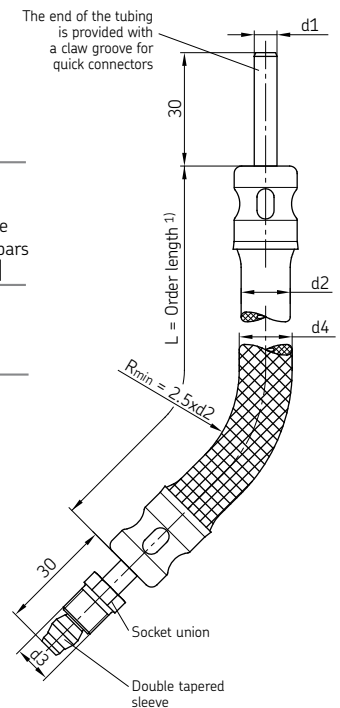

Accessories

Hoses suitable for self-installation, operating pressure 45 bars

Tube diam. d1	①	②		③		Hose diam. d2	Increase in volume at ≈ 40 bars [cm ³ /m]
	Male body Order No.	WAF	Shell Order No.	WAF	Hose Order No. ¹⁾		
4	406-704-001(-VS) ²⁾	8	406-804-001	14	WVN701-4	11	1
6	406-706-001(-VS) ²⁾	10	406-806-001	17	WVN701-6	13	1.4
8	406-708-001(-VS) ²⁾	13	406-808-001	19	WVN701-8	15	1.4

¹⁾ Please quote length when ordering. Max. length available 20 m.

²⁾ For Version with claw groove on ends of tubing for quick connectors, order No.: ...-VS

Material: Hose: Perbunan, resistant to mineral oils, with two layers of braided rayon
Male body: steel, galvanized
Shell: brass

Permissible operating temperature: -40 °C to +100 °C

Installation instructions

- Apply thin film of oil to thread and inside of hose of parts ① ② ③ to be connected.
- Clamp shell ② in vise and screw in hose ③ by turning it to the left up to the stop.
- Important note:** To avoid damages screw in male body ① with a wrench up to the stop. **Do not tighten!**

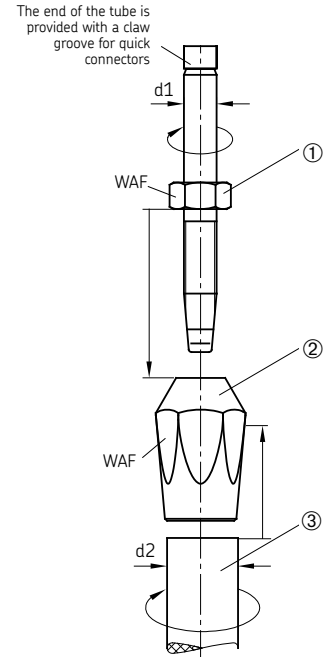

High pressure hoses, operating pressure: 280 – 330 bars

Order No.	Tube diam. \varnothing d1	Hose diam. \varnothing d2	Length ¹⁾ l ⁵	l1	Permissible operating pressure R _{min} [bar]		Burst pressure [bar]
SLH6-180	6	10.9	180	22	19	225	900
SLH8-180	8	13	180	30	32	210	830
SLH10-180	10	14.5	180	30	44	175	690

¹⁾ Order length in mm; other lengths available.

Order example: highpressure hose SLH8, 600 mm long, order No.: SLH8-600

Material: Inner liner: PA 11/12 or PE-E
Reinforcement: 1 braided layer of synthetic fibre with high tensile strength
Outer cover: PA 11/12
Resistant to mineral oils.

Permissible operating temperature: -40 °C to +100 °C

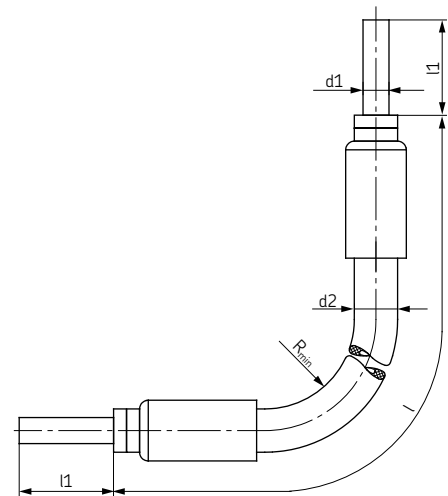

Accessories

High pressure hoses for self-installation

for main line for tube diam. 6 (NW4) (connection: pump – feeder) and secondary lines (connection: feeder – lubrication point)

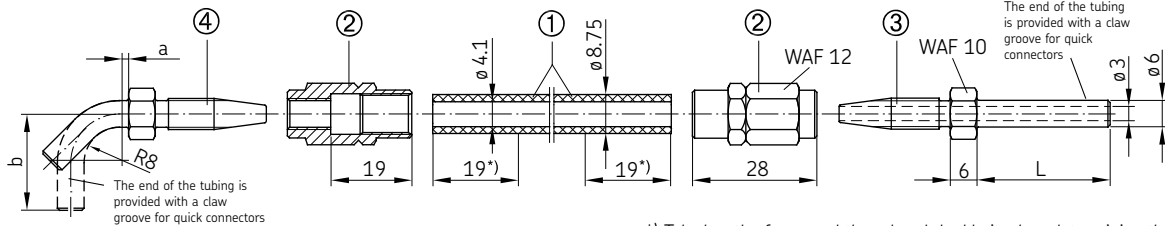

*) Take length of engaged thread and double it when determining the length of the hose.

Designation	Order No.	L	a	b
① High press. hose, max. length supplied 50 m	982-750-091			
High press. hose, max. length supplied 50 m filled with NLGI grade 2 grease	982-750-091+AF2			
② Sleeve	853-540-010			
③ Tube stud, straight	853-370-002(-VS) ¹⁾	20		
	853-380-002(-VS) ¹⁾	30		
	853-390-002(-VS) ¹⁾	66		
④ Tube stud, 45° angle	853-380-004(-VS) ¹⁾			
Tube stud, 90° angle	853-380-003		2	21
	853-380-003-VS ¹⁾		2	35
	853-390-003(-VS) ¹⁾		13	47

Technical data:

Hose: operating pressure: 325 bars
burst pressure: 800 bars
min. bending radius: 35 mm

Material

Hose: Inner lining: unplasticized polyester
Inner layer: braided synthetic fibers
Outer cover: weatherproof polyurethane
Sleeve, tube stud: steel, galvanized

Permissible operating temperature: -30 °C to +70 °C

¹⁾ Version with claw groove on ends of tubing for quick connectors, order No.: ...-VS

for main line for tube diam. 8 (NW6) (connection: pump – feeder) and secondary lines (connection: feeder – lubrication point)

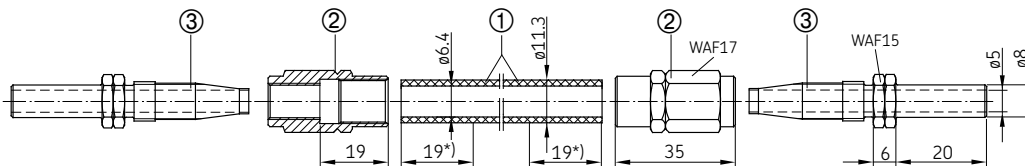

*) Take length of engaged thread and double it when determining the length of the hose.

Designation	Order No.
① High press. hose, max. length supplied 50 m	982-750-111
High press. hose, max. length supplied 50 m filled with NLGI grade 2 grease	982-750-111+AF2
② Sleeve	406-808-005
③ Tube stud, straight	406-708-005
Tube stud, straight	406-708-007
Tube stud, 45° angle	406-708-009
Tube stud, 90° angle	406-708-008

Technical data

Hose: operating pressure: 280 bars static / 210 bars dynamic
burst pressure: 840 bar
min. bending radius: min. 50 mm

Material

Hose: Inner lining: unplasticized polyamide
Inner layer: braided synthetic fibers
Outer cover: weatherproof polyurethane, black
Sleeve, tube stud: steel, galvanized

Permissible operating temperature: -30 °C to +70 °C

for main lines for tube diam. 10 (NW8) (connection: pump – feeder)

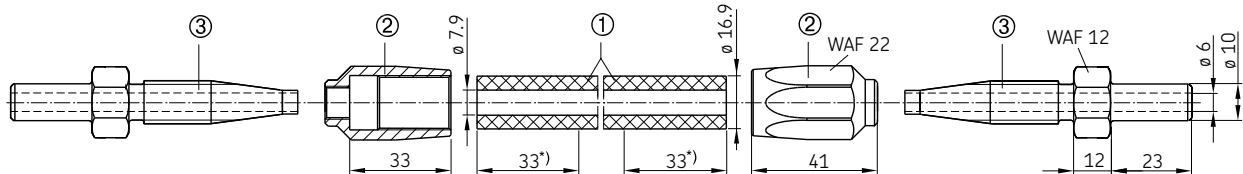

*) Take length of engaged thread and double it when determining the length of the hose.

Designation	Order No.
① High press. hose, max. length supplied 100 m	WVN711-10
High press. hose, max. length supplied 50 m filled with NLGI grade 2 grease	WVN711-10+AF2
② Sleeve	406-810-002
③ Tube stud, straight	406-710-002

Technical data

Hose: operating pressure: 130 bars
burst pressure: 315 bars
min. bending radius: 55 mm

Material

Hose: Inner lining: Perbunan
Inner layer: diagonally woven synthetic fibers
Outer cover: weatherproof neoprene

Sleeve: aluminum
Tube stud: steel, galvanized

Permissible operating temperature: -40 °C to +100 °C

Accessories

Rotating joints

Rotating joints connect fixed tubing with oscillating and rotating machine parts.

Order No.	Tube outside diam.	d1	d2 *)	Max. Speed [rpm]	Max. pressure oil [bar]	Max. pressure air [bar]
401-504-192	4	G 1/8 A	M8x1			
401-504-292	4	M8x1	M8x1	100	30	8
401-506-313	6	M10x1	M10x1			

Flow media: mineral oils, oiled compressed air

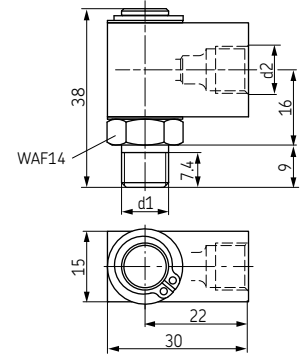

Banjo fitting, rotatable

Order No.	Tube outside diam.	d1
405-549-049	4	M8x1 tap.
405-551-049	4	M10x1 tap.

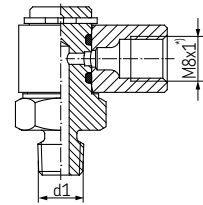

Order No.	Tube outside diam.	d1	Max. speed [rpm]	Max. pressure oil [bar]	Max. pressure air [bar]
DLY930-2	8	G 1/4 A	1400	20 ¹⁾	8
DLY931		R 1/8 tap.			

Flow media: mineral oils, oiled compressed air

¹⁾ 30 bars in singleline centralized lubrication systems for a short time.

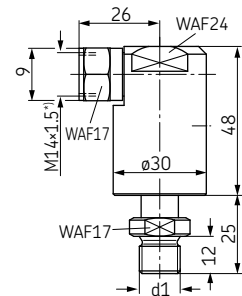

Order No.	Tube outside diam.	Max. speed [rpm]	Max. pressure [bar]
DLY932	6	1400	5

Flow medium: mineral oil

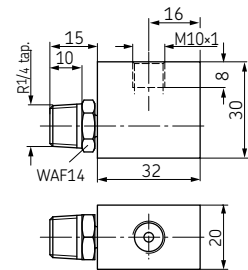

Order No.	Tube outside diam.	Max. speed [rpm]	Max. pressure [bar]
408-120	8	20	10

Flow medium: mineral oil

The rotating joint is also available with nut DIN936M22x1.5 and spring washer DIN137-B22.

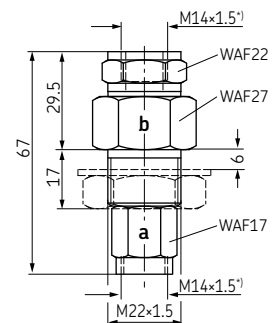

^{*)} Ports tapped for solderless tube connection

Accessories

Pressure gauges

Order No.	Indication range	
248-602.25	0-10 bars	
169-102-506	0-25 bars / 0-360 psi	
248-602.20	0-40 bars	for grease
169-104 008	0-40 bars	for oil
169-106-004	0-60 bars	

Fixed by means of a double tapered sleeve and socket union (solderless tube connection) in counterbore acc. to DIN 3854/DIN 3862.

Order No.	Indication range	Adaptor Order No.	d
169-101-004	0-10 bar		
248-604.00	0-25 bar		
169-104-020	0-40 bar / 0-580 psi / 0-4 Mpa		
169-106-020	0-60 bar / 0-870 psi / 0-6 Mpa	301-134	M10×1
169-110-020	0-100 bar / 0-1450 psi / 0-10 Mpa	301-034	M14×1.5
169-116-000	0-160 bar		
169-125-020	0-250 bar / 0-3625 psi / 0-25 Mpa		

Washer, order No. 248-610.02, must be ordered separately for every pressure gauge.

Damped version with glycerine filling

Order No.	Indication range	Mounting position
169-102-015	0-25 bar	
169-104-015	0-40 bar / 0-580 psi / 0-4 Mpa	
169-106-015	0-60 bar / 0-870 psi / 0-6 Mpa	vertically
169-110-015	0-100 bar / 0-1450 psi / 0-10 Mpa	
169-125-015	0-250 bar / 0-3625 psi / 0-25 Mpa	
169-140-001	0-400 bars	

Washer, order No. 248-610.02, must be ordered separately for every pressure gauge.

Version with visualization

Order No.	Indication range	Mounting position
169-101-607	0-16 bars / 0-1.6 MPa	
169-104-011	0-40 bars / 0-4 MPa	
169-106-011	0-60 bars / 0-6 MPa	vertically
169-110-010	0-100 bars / 0-10 MPa	

Washer, order No. 248-610.02, must be ordered separately for every pressure gauge.

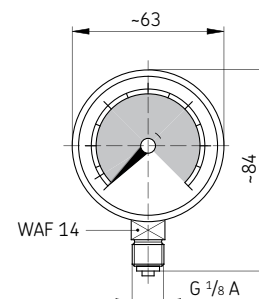
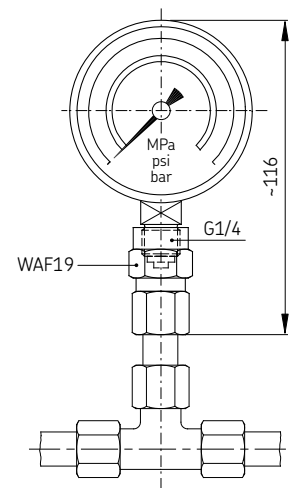
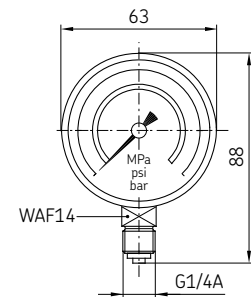
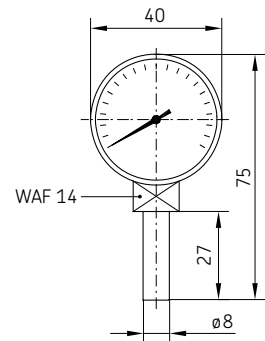

Accessories

Shut-off valves

Order No.	Max. pressure [bar]	Max. temperature [°C]	Spindleway
202-085-S	60	80	max. 3 revs.

Direction of flow optional

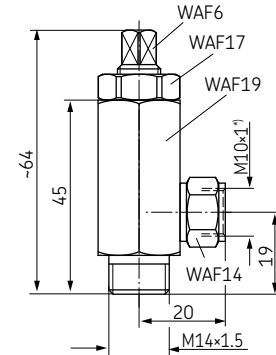

Order No.	Max. pressure [bar]	Max. temperature [°C]
161-600-036	16	90

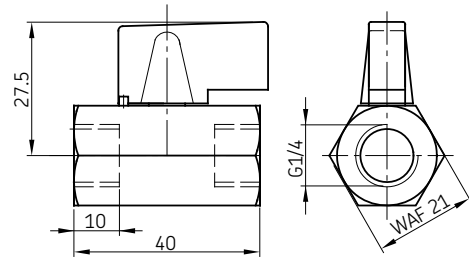

^{*)} Ports tapped for solderless tube connection

Quick-disconnect couplings

Coupling, complete

Order No.	Tube diam.	d1 *)	l2	Flow direction
207-168-2	6	M10x1	62	optional
207-188-2	8	M14x1.5	66,5	

Outer coupling member

Order No.	Tube diam.	l1
207-168.U7	6	48,5
207-188.U11	8	53

Inner coupling member

Order No.	207-168.U2
-----------	------------

Both coupling members are shut off when disconnected!

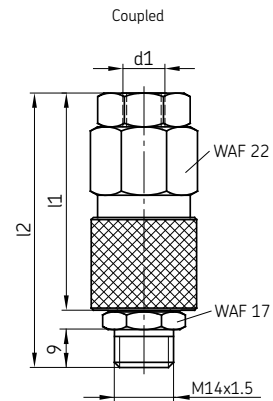

Pressure loss as a function of the flow rate based on an operating oil viscosity of 140 mm²/s

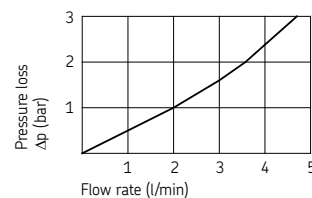

^{*)} Ports tapped for solderless tube connection

Accessories

Relief valves

These valves are installed in distributor systems fitted with a pump without pressure relief equipment, mainly in the main line downstream from the pump.

With longer main lines and high viscosity oils, the pressure relief time, which influences the reversing of the distributors, can become too long. The installation of the second relief valve at a suitable position in the main line, e.g. at half the main line length, may remedy this problem.

Order No. 202-275-2

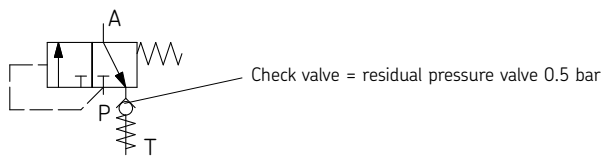

A = Outlet
P = Inlet
T (R) = Return

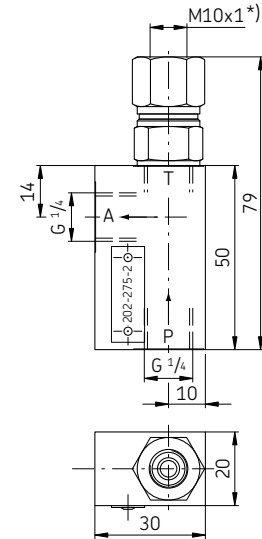

Relief valve with bleed valve and safety valve

Order No. 202-175-30

Adaptors *) for tube diam. 6: Order No. 406-054
for tube diam. 8: Order No. 301-020
for tube diam. 10: Order No. 410-163

Fitted to reservoir

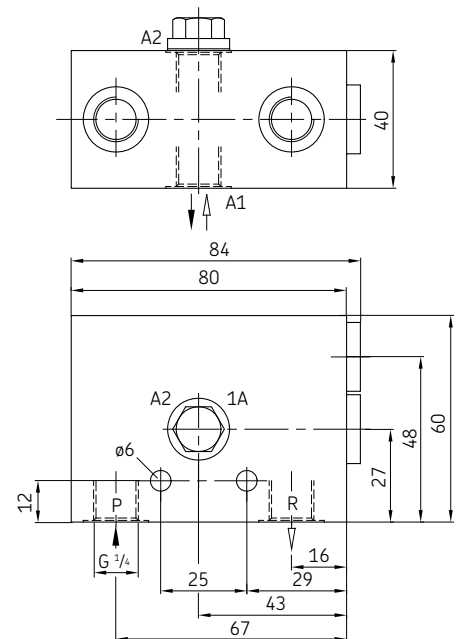
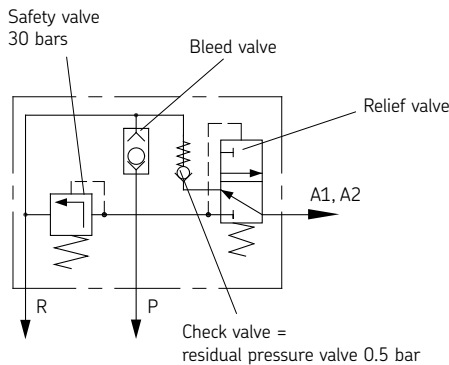
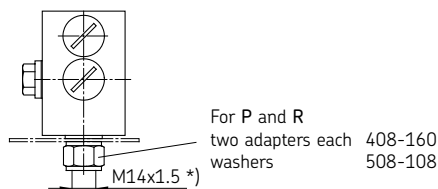

*) Ports tapped for solderless tube connection

Accessories

Safety valves, adjustable (poppet valve)

Hydraulic characteristics

Order No.	Rated flow rate [l/min]	Adjustable pres. range [bar]	Operating pres. max. [bar]	Oil temperature max.	Viscosity range mm ² /s	Seal
WVN200-10E6		1 to 6	40			NBR
WVN200-10E12		3 to 12	40			NBR
WVN200-10E12-S8	see	3 to 12	40			FKM (FPM)
WVN200-10E25	pressure-	4 to 25	40	80 °C	20 to 1000	NBR
WVN200-10E25-S8	loss	4 to 25	40			FKM (FPM)
WVN200-10E35	parameter	4 to 35	40			NBR
WVN200-10E60		12 to 60	70			NBR
WVN200-10E60-S8		12 to 60	70			FKM (FPM)

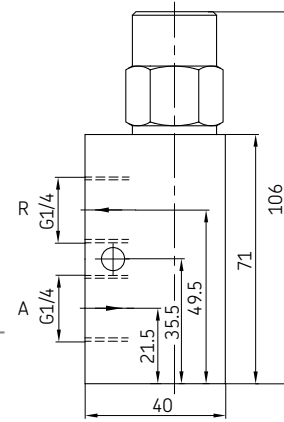

General characteristics

Design: poppet valve with hydraulic cushioning directly controlled
 Lubricant: oil
 Connecting thread: G 1/4
 Mounting position: optional

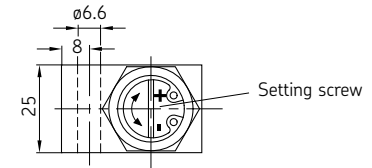
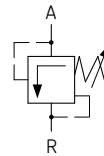

Pressure loss parameter

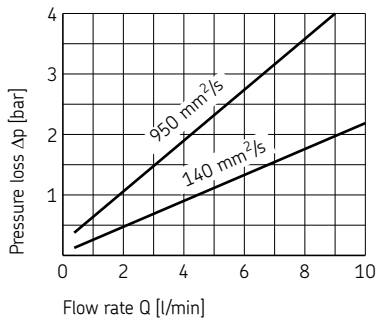

With increasing flow rate, the pressure upstream from the valve will also rise in accordance with the curves.

Adaptors *)

for valves **WVN200-10E6 to WVN200-10E35**

for tube diam. 8: Order No. 301-020
 for tube diam. 10: Order No. 410-163
 for tube diam. 12: Order No. 412-163

Washer: Order No. 508-108

for valve **WVN200-10E60**

for tube diam. 8: Order No. 408-403W
 for tube diam. 10: Order No. 410-403W
 Washer: Order No. 508-108

If installed on a reservoir, use **two special adaptors 408-160** with long tube ends.

*) Ports tapped for solderless tube connection

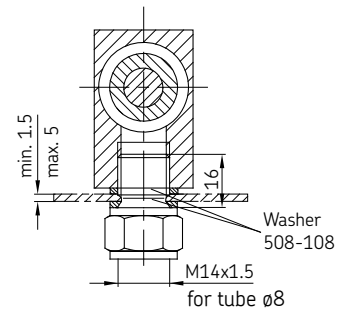

Check valve (Kugelventile)

Order No.	Tube diam. d1	G	Opening pressure [bar]	Pressure, max. [bar]	Series
VPG-RV	4	R 1/8 tap.	10	100	LL
VPG-RV6	6	R 1/8 tap.	10	315	L
VPG-RV8	8	R 1/8 tap.	10	315	L
VPM-RV4	4	M10x1 tap.	10	100	LL
VPM-RV	6	M10x1 tap.	10	315	L
VPM-RV8	8	M10x1 tap.	10	315	L
VPM-RV10	10	M10x1 tap.	10	315	L
VPKG-RV	6	R 1/8 tap.	3	100	LL
VPKM-RV-S3*	6	M10x1 tap.	3	100	LL
VPKM-RV-S4	6	M10x1 tap.	2	100	LL

* Stainless steel

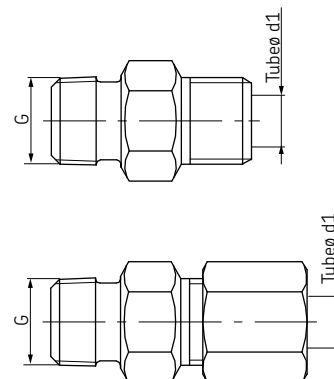

Check valves for quick connectors, see page 21.

LL-series = extra light version, L-series = light version

Accessories

Safety valves, (ball valves) for flow rates from 0.5 to 2 l/min

Order No.	Tube diam.	Opening pressure [bar]	Marking	d1 *)
WVN200-4A0.4	4	0.4	04	M8×1
WVN200-4A5		5	5	
WVN200-4A8		8	8	
WVN200-4A12		12	12	
WVN200-4A16		16	16	
WVN200-4A25		25	25	
WVN200-4A0.4-S1	6	0.4	04	M10×1

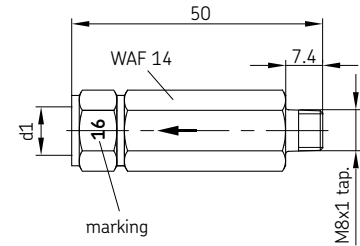

Order No.	Tube diam.	Opening pressure [bar]	Marking	d1 *)	l1	WAF
WVN200-6B0.5	6	0.5	05	M10×1	61	14
WVN200-6B3		3	3			
WVN200-6B8		8	8			
WVN200-6B12		12	12			
WVN200-6B16		16	16			
WVN200-6B20		20	20			
WVN200-6B40	40	40	40			
WVN200-8B0	8	0.04	0	M14×1.5	71	17
WVN200-8B3		3	3			
WVN200-8B5		5	5			
WVN200-8B12		12	12			
WVN200-8B16		16	16			
WVN200-8B20		20	20			
WVN200-8B32	32	32	32			
WVN200-10B0	10	0.04	0	M16×1.5	80	19
WVN200-10B0.5		0.5	05			
WVN200-10B1		12	12			
WVN200-10B32		32	32			
161-212-054 ¹⁾	8	20	20	M14×1.5	84.5	17

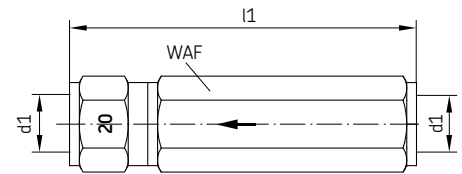

¹⁾ This valve is designed as a plunger valve. Because of this design it can also be used for regulating tasks, whereas the ball valves should be used as safety valves..

Order No.	Tube diam. d	Opening pressure [bar]	Marking	l1
WVN200-8D50	8	50	50	84
WVN200-8D75		75	75	
WVN200-8D120		120	120	
WVN200-8D220		220	220	
WVN200-10D120-S1	10	120	120	87
WVN200-10D220-S1		220	220	

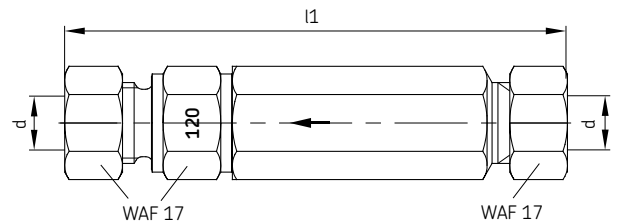

Cutting sleeve screw unions according to DIN 2353

*) Ports tapped for solderless tube connection

Accessories

Oil reservoirs – plastic

Plastic reservoirs

Order No.	Reservoir capacity [liters]	Level indicator WS	Type of contact	Seal material
K1 KW1 KW1-S2	1	– for min. filling level for min. filling level	– NC NC	NBR
K3-S2 KW3-S1 KW3-S3 KW3-S5	3	– for min. filling level for min. and max. filling level for min. filling level with advance warning	– changeover 1 NC, 1 NO	NBR
K6-S5 KW6-S1 KW6-S2 KW6-S81 KW6-V57	6	– for min. filling level for min. filling level with advance warning for min. filling level for min. filling level with advance warning	– changeover 2 NCs changeover NBR	NBR NBR NBR FKM (FPM)

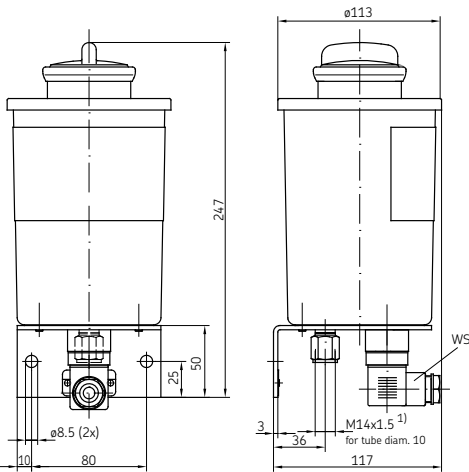

1-liter reservoir (shown: KW1)

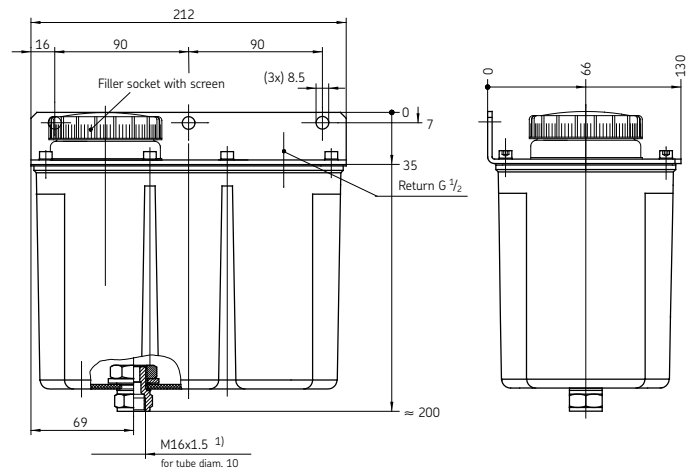

3-liter reservoir (shown: K3-S2)

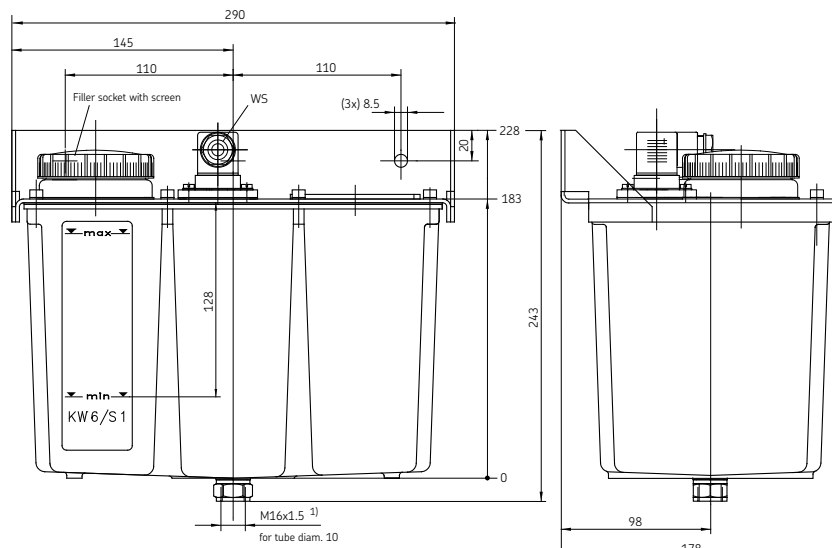

6-liter reservoir (shown: KW6-S1)

¹⁾ Ports tapped for solderless tube connection to DIN 2367

Accessories

Oil reservoirs – metal

Metal reservoirs

Order No.	Reservoir capacity [liters]	Level indicator WS	Type of contact	Seal material
B3-S1 BW3-S81 162-210-005	3	- for min. filling level for min. filling level	- changeover changeover	NBR FKM (FPM) NBR
B7 BW7-S6 BW7-S7 BW7-S8 BW7-S11 BW7-S12 162-310-005	6	- for min. and max. filling level for min. filling level with advance warning for min. filling level for min. filling level with advance warning for min. filling level with advance warning for min. filling level	- 2 NCs 2 NCs changeover 1 NO, 1 NC 1 NO, 1 NC changeover	NBR NBR NBR FKM (FPM) NBR NBR NBR

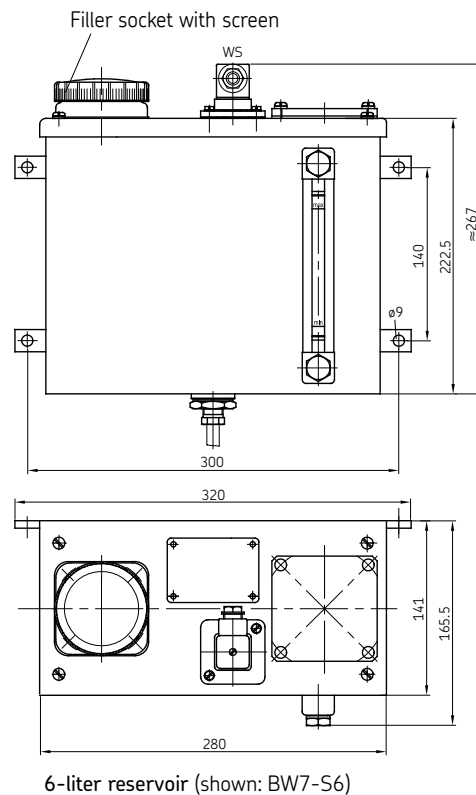
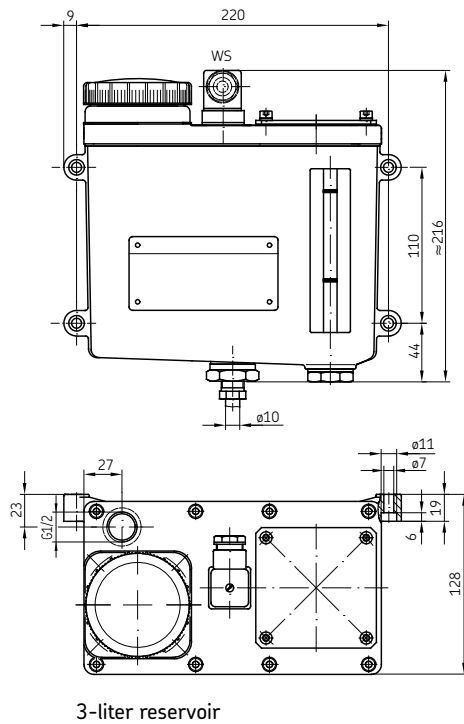

Oil level gauges for metal reservoir

Order No.	Reservoir capacity [liters]	l	l1
995-003-044	6	152	127
995-003-040	6	190	165
995-003-041	15 and 30	215	190
995-003-042	50	279	254
995-003-043	100	305	280

Type: NBR
FKM (FPM) on request

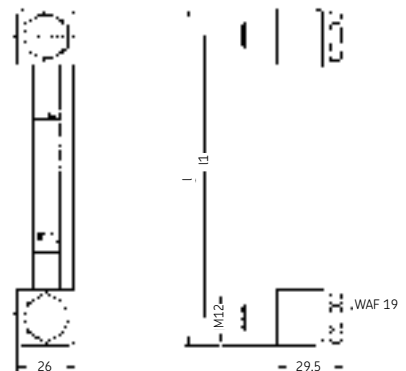

Accessories

Filler coupling for oil and fluid grease

Coupling plug

Order No.	Fig.	øA	L	Respective dust cover Order No.	Respective coupling socket Order No.
995-001-501	1	G ¹ / ₄	57.5	995-001-503	995-002-073
995-001-502	1	G ¹ / ₂	82	995-001-504	995-001-950
995-000-705	2	G ¹ / ₄	-	-	995-001-500
995-001-260	3	G ¹ / ₂	83	-	-

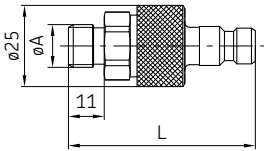

Fig. 1

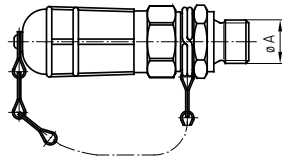

Fig. 2

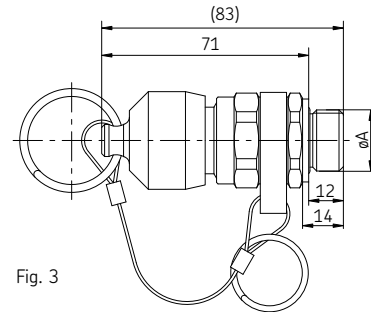

Fig. 3

Topping-up pumps

Order No.	Drum (kg)	Medium	Operating	Trolley	
169-000-004	15				
169-000-012	10	NLGI 1,2	manually operated	no	-
169-000-016	20				
169-000-056	25				
169-000-082	25 / 50	00/000	manually operated	yes	
169-000-084	25	00/000	manually operated	yes	Fig.
169-000-042	25	NLGI 1,2	manually operated	yes	-
169-000-054	50				
169-000-342	25	NLGI 1,2	manually operated	no	-
169-000-018	25	00 to 2	pneum. operated	yes	-

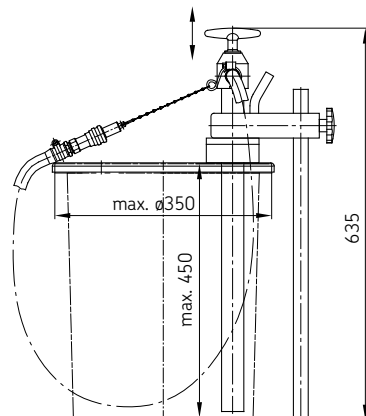
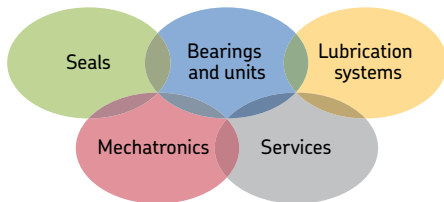

Fig.



The Power of Knowledge Engineering

Drawing on five areas of competence and application-specific expertise amassed over more than 100 years, SKF brings innovative solutions to OEMs and production facilities in every major industry worldwide. These five competence areas include bearings and units, seals, lubrication systems, mechatronics (combining mechanics and electronics into intelligent systems), and a wide range of services, from 3-D computer modelling to advanced condition monitoring and reliability and asset management systems. A global presence provides SKF customers uniform quality standards and worldwide product availability.

Additional brochures for further information

- 1-0116-EN *Filters*
- 1-9201-EN *Transport of Lubricants in Centralized Lubrication Systems*

SKF Lubrication Systems Germany AG

Berlin Plant
Motzener Str. 35/37 · 12277 Berlin
PO Box 970444 · 12704 Berlin · Germany

Tel. +49 (0)30 72002-0
Fax +49 (0)30 72002-111

This brochure was presented to you by:

© SKF is a registered trademark of the SKF Group.

© SKF Group 2011

The contents of this publication are the copyright of the publisher and may not be reproduced (even extracts) unless prior written permission is granted. Every care has been taken to ensure the accuracy of the information contained in this publication but no liability can be accepted for any loss or damage whether direct, indirect or consequential arising out of the use of the information contained herein.

1-0103-EN · June 2011

This publication supersedes publication 1-0103-1-EN.

