

# S.C. MOUNTING



(1) Natural frequency:  
6 to 30 Hz

## DESCRIPTION

The S.C. mounting comprises an annular section bonded between the inner tube and outer housing.  
The outer housing has a mounting flange (4 different types).

## OPERATION

The design of the S.C. mounting gives the following basic characteristics:

- Axial elasticity four times higher than radial elasticity.
- The rubber works in shear.
- Progressive buffer against shocks or accidental overload, provided that a large metal washer is used to bear against the rubber dome.
- Can be used as a fail safe assembly when fitted as in figure 1.

### Advantages:

- Extensive range: 3 hardnesses of rubber for 20 existing types, allowing the mounting to be optimised as a function of the load and exciting frequency.

### Recommendations:

- In order not to affect the performance of the mounting system, all external connections must be flexible.
- S.C. mountings must be fitted so that the vibration input is in the axial direction.

(1) Natural frequencies with max/min loads, see: OPERATING CHARACTERISTICS.

# DIMENSIONS

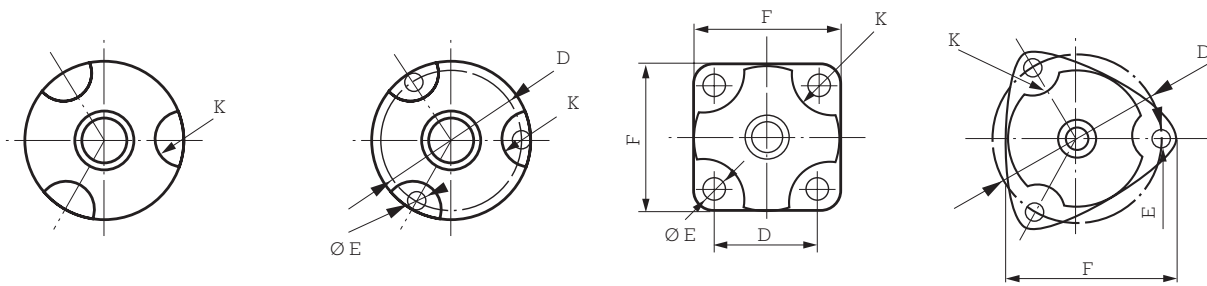
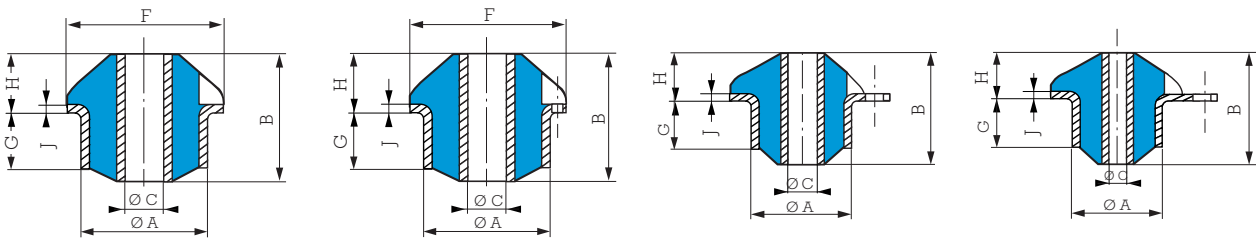

Fig. a

Fig. b

Fig. c

Fig. d

TYPE	Reference				Ø A mm	B mm	Ø C mm	D mm	E mm	F mm	G mm	H mm	J mm	K mm	Weight g
	With fixing holes	Without fixing holes													
S.C. 000	<b>531201</b>	Fig. c	--	--	20	11	6.2	19	3.2	25	3	7	1	4	8
S.C. 00	<b>531301</b>	Fig. c	--	--	26	28	8	26	5.2	36	12.5	11.5	1.5	12	40
S.C. 01	--	--	<b>531401</b>	Fig. a	37.5	40	12.1	--	--	48	18	18	2	8	110
S.C. 02	--	--	<b>531402</b>	Fig. a	37.5	51	12.1	--	--	48	24	18	2	8	130
S.C. 10	<b>531216</b>	Fig. d	--	--	49.1	47	12.2	69	8.2	72	20	18	2	12	190
S.C. 11	<b>531611</b>	Fig. d	--	--	49.1	60	12.2	69	8.2	72	31	18	2	12	290
S.C. 20	--	--	<b>531701</b>	Fig. a	55.7	55	18.2	--	--	70	27	19	3	10	370
S.C. 21	--	--	<b>531702</b>	Fig. a	55.7	70	18.2	--	--	70	39	19	3	18	480
S.C. 21	<b>531240</b>	Fig. d	--	--	57.2	70	18.2	86	10.5	90	39	19	3	18	500
S.C. 30	<b>531259</b>	Fig. b	--	--	65	75	20.2	78	8.5	90	29	28	3	18	560
S.C. 31	<b>531261</b>	Fig. d	--	--	66.5	93	20.2	95	8.5	107	47	28	3	18	780
S.C. 40	<b>531714</b>	Fig. d	--	--	76	90	22.2	100	8.5	112	42	28	3	18	880
S.C. 41	<b>531327</b>	Fig. d	--	--	76	110	22.2	100	8.5	112	49	28.5	3	18	960
S.C. 50	<b>531939</b>	Fig. d	--	--	87.5	100	40.2	114	8.5	127	47	33	3	20	1300
S.C. 51	<b>531947</b>	Fig. b	--	--	86	120	40.2	104	10.5	120	63	33	3	20	1500
S.C. 70 red.	<b>531933</b>	Fig. b	--	--	118	98	60.2	145	10.5	164	36	46	4	22	2200
S.C. 70	<b>531932</b>	Fig. b	--	--	118	140	60.2	145	10.5	164	66	46	4	22	3000
S.C. 71	<b>531931</b>	Fig. b	--	--	118	170	60.2	145	10.5	164	96	46	4	22	3800
S.C. 80	<b>531940</b>	Fig. b	--	--	170	167	80	204	12.2	230	95	53	5	30	7100
S.C. 81	<b>531941</b>	Fig. b	--	--	170	185	80	204	12.2	230	113	53	5	30	7700

See current price list for availability of items.

# OPERATING CHARACTERISTICS

Nominal static load daN	Deflect. mm	Reference	Hard.	Nominal static load daN	Deflect. mm	Reference	Hard.	Nominal static load daN	Deflect. mm	Reference	Hard.
1-6	1	531201	45	35-150	1.5	531611	75	110-440	3.5	531939	60
2-8	0.8	531201	60	35-150	3	531701	60	110-450	3	531327	75
2-10	0.5	531201	75	40-175	5	531259	45	110-450	6.5	531933	45
5-20	1.5	531301	45	45-180	2	531701	75	135-550	2.5	531939	75
7-30	1.2	531301	60	45-190	3	531240	60	135-550	3.5	531947	60
10-40	0.8	531301	75	45-190	3	531702	60	150-600	5	531933	60
10-50	2.5	531401	45	55-225	5	531714	45	165-670	2.5	531947	75
15-65	1.8	531401	60	60-240	3.5	531259	60	175-700	6.5	531932	45
15-65	2.5	531402	45	60-250	2	531240	75	210-850	6.5	531931	45
15-70	4	531216	45	60-250	2	531702	75	225-900	5	531932	60
20-80	1.5	531401	75	60-250	5	531261	45	275-1100	3	531932	75
20-85	1.8	531402	60	60-250	5	531327	45	275-1100	5	531931	60
20-85	4	531611	45	75-300	2	531259	75	310-1250	11	531940	45
25-100	3	531216	60	80-320	4.5	531714	60	350-1400	3	531931	75
25-100	3.5	531701	45	80-325	4.5	531939	45	400-1600	11	531941	45
25-110	1.5	531402	75	85-350	3.5	531261	60	450-1800	8.5	531940	60
30-120	2	531216	75	90-360	4.5	531327	60	525-2100	8.5	531941	60
30-120	3	531611	60	95-380	3	531714	75	575-2300	5	531940	75
30-135	3.5	531240	45	100-400	4.5	531947	45	650-2600	5	531941	75
30-135	3.5	531702	45	105-420	2	531261	75				

1 kg ≈ 1 daN

## LOAD/DEFLECTION CURVES IN AXIAL COMPRESSION

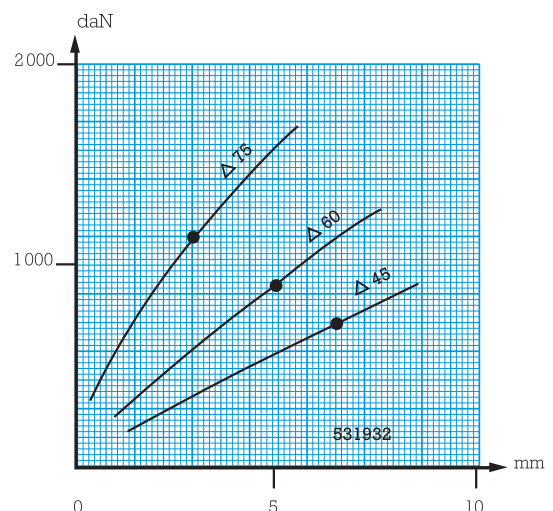
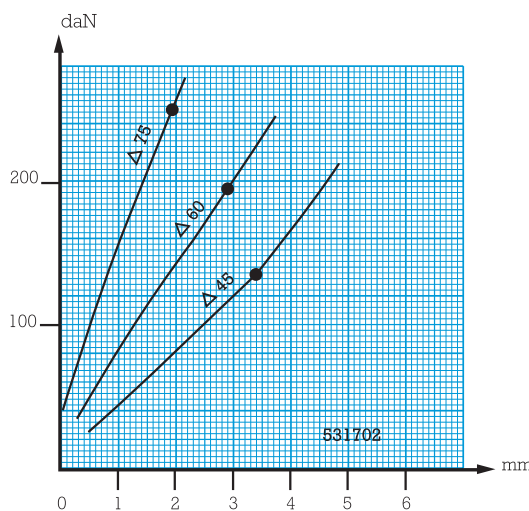
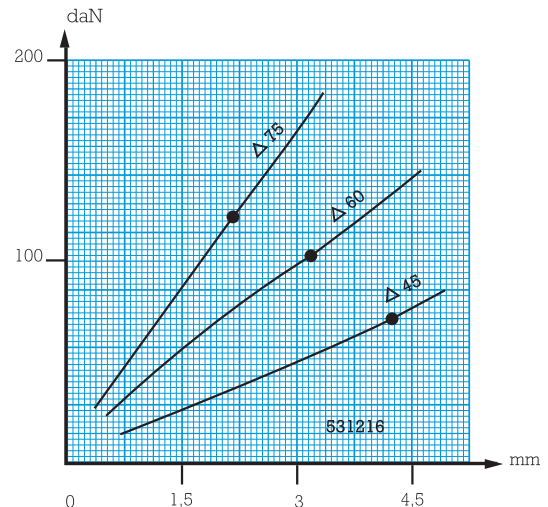
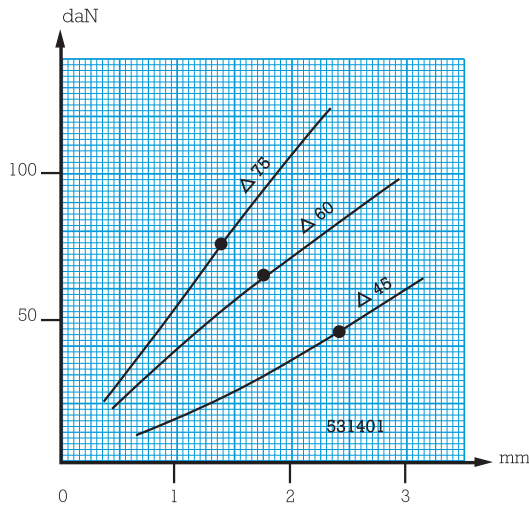

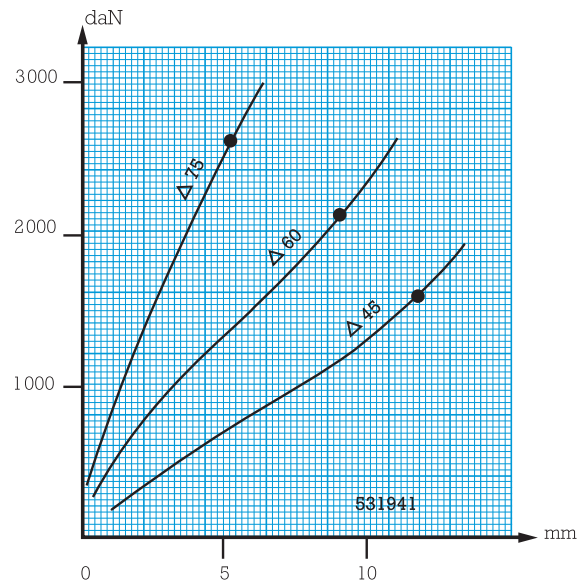
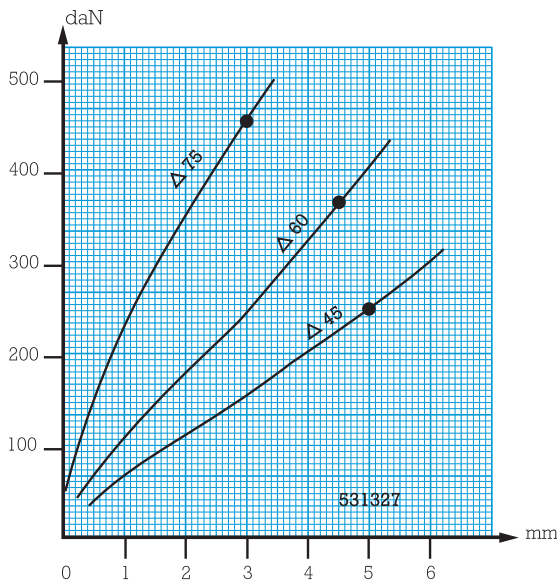

## ASSEMBLY

### • Standard fixing

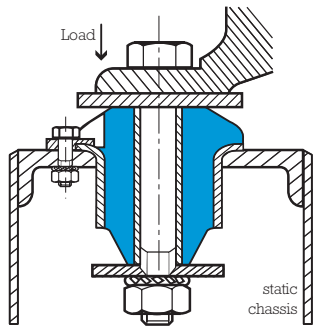

Fig. 1 - Fixing between the equipment and a metallic chassis (failsafe in mobile applications).

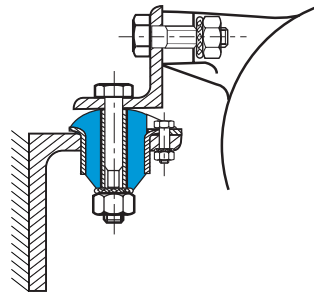

Fig. 2 - Fixing between two brackets onto a vertical surface (non failsafe).

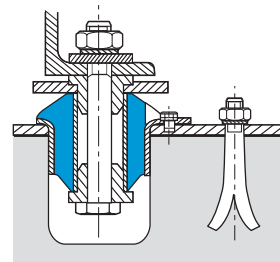

Fig. 3 - Fixing between the equipment and concrete (using locating rings).

### • Reversed fixing

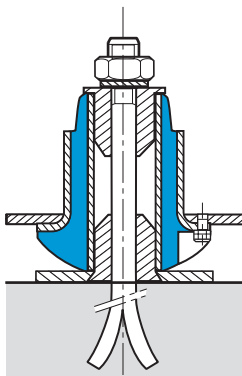

Fig. 4

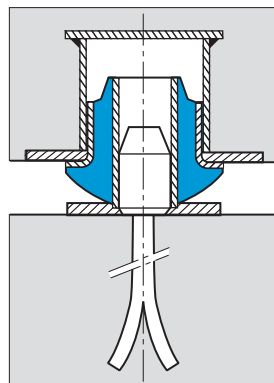

Fig. 5 - Fixing between inertia base and foundation. The inertia base increases the suspended mass and thus reduces the amplitudes of the vibrations as well as lowering the natural frequency.

### • Mounting in tandem

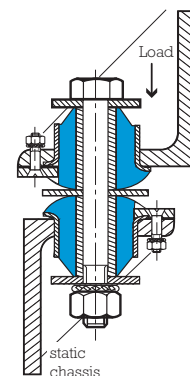

Fig. 6 - Two mountings fixed face to face. Provides twice the deflection under the same load.