

Enerpac offers a complete line of pullers with the widest range of sizes, capacities and styles. Whether your application requires mechanical, hydraulic or the patented Posi Lock® system, Enerpac can satisfy your requirements.

Made of high strength steel alloys, you can depend on Enerpac pullers to provide years of trouble-free operation, even in the harshest environments.



Hydraulic Pullers

These hydraulic pullers eliminate time-consuming and unsafe hammering, heating or prying. Damage to parts is minimized through the use of controlled hydraulic power.



Posi Lock® Pullers

The puller that meets the safety challenge. A control cage holds the pulling jaws securely in working position. This patented feature reduces the possibility of the puller jaws slipping off the work surface, thereby increasing productivity and tool life and

reducing dangerous situations for the user. The Posi Lock® feature is available in a mechanical or hydraulic version.



WARNING

Do not exceed 50% of the rated puller capacity when using two jaw configurations, a double crosshead (2 grip arms) or when using puller legs in combination with bearing puller attachments.



CAUTION!

Not all puller components and configurations are rated at the set capacity. Please contact Enerpac for details.



IMPORTANT!

Always wear Safety Goggles and Gloves while using pullers.

Puller Section Overview

When selecting a puller it is important to consider 3 basic specifications:

1. The Capacity:

is the amount of force the puller is capable of producing.

Typically, the capacity required for a job can be determined by using the shaft diameter of the part being pulled.

For manual pullers, the center bolt diameter of the puller should be at least half the diameter of the shaft being pulled from.

For hydraulic pullers, the capacity in tons should be 0,28 to 0,4 times the shaft diameter in mm. Use the following chart:

Shaft Diameter	Puller Capacity
0 - 25 mm	13 ton
25 - 50 mm	22 ton
50 - 89 mm	33 ton
89 - 140 mm	45 ton

2. The Reach:

is the distance between the bottom of the base and the jaw flats. The puller's reach must equal or exceed the same distance of the part being pulled.

3. The Spread:

is the distance between the jaws. The puller's spread needs to be greater than the width of the part being pulled.

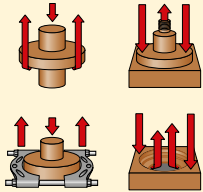
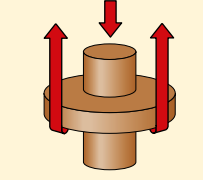
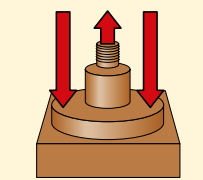
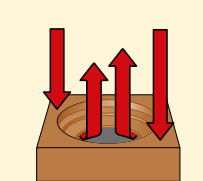
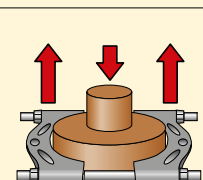
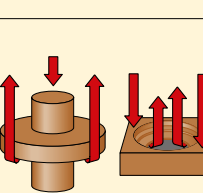
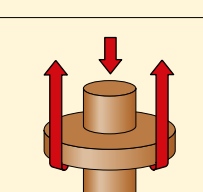
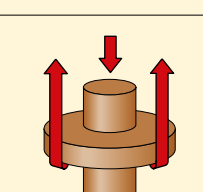
Puller Function	Capacity ton	Puller Type	Series	Page
	13-45	Master Puller Sets Max. Reach: 252 - 700 mm Max. Spread: 247 - 1100 mm	BHP	144 ▶
	13-45	Grip Puller Sets Max. Reach: 252 - 700 mm Max. Spread: 249 - 1100 mm	BHP	145 ▶
	6-22	Cross Bearing Puller Sets Max. Reach: 357 - 864 mm Max. Spread: 260 - 580 mm	BHP	146 ▶
	6-22	Bearing Cup Pullers Max. Reach: 115 - 150 mm Max. Spread: 145 - 240 mm	BHP	147 ▶
	6-22	Bearing Separators Max. Width: 110 - 260 mm Max. Spread: 110 - 250 mm	BHP	147 ▶
	2-40	Posi Lock® Mechanical Pullers Max. Reach: 101 - 355 mm Max. Spread: 12 - 635 mm	EP EPP EPX EPPMI	148 ▶
	10-50	Posi Lock® Hydraulic Pullers Max. Reach: 203 - 355 mm Max. Spread: 304 - 635 mm	EPH EPHR EPHS	152 ▶
	100	Posi Lock® Hydraulic Pullers Max. Reach: 1219 mm Max. Spread: 190 - 1778 mm	EPH	155 ▶

▼ Shown: Master Puller Set BHP-3751G



Multi Purpose Puller Set



WARNING

Do not exceed 50% of the rated puller capacity when using two jaw configurations, a double crosshead (2 grip arms) or when using puller legs in combination with bearing puller attachments.

- Supplied with a full hydraulic set including pump, hose, cylinder, gauge, gauge adaptor and wooden case
- High quality, forged steel components provide superior reliability and service
- Sets include speed crank and adjusting screw for fast contact to work before hydraulics are applied
- All Master Puller Sets include a Grip Puller, a Cross Bearing Puller, a Bearing Cup Puller and a Bearing Separator, which can be ordered separately, see items nr. 10, 20, 30 and 40.

▼ Maintenance engineers throughout the industry greatly appreciate the Enerpac Master Puller sets

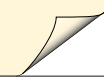

▼ SELECTION CHART

Master Puller Set Capacity *		13 ton	22 ton	33 ton	45 ton **	Page:
Model Number ▶		BHP-1752 ¹⁾	BHP-2751G	BHP-3751G	BHP-5751G	
Included Hydraulics	Set Weight ▶	37 kg	90 kg	172 kg	298 kg	
• Hand Pump		P-142	P-392	P-392	P-80	
• Cylinder		RWH-121	RCH-202	RCH-302	RCH-603	26 ▶
• Saddle		–	HP-2015	HP-3015	HP-5016	27 ▶
• Hose		HB-7206QB	HC-7206	HC-7206	HC-7206	116 ▶
• Gauge		GF-120B	GF-813B	GF-813B	GF-813B	122 ▶
• Gauge Adaptor		GA-4	GA-3	GA-3	GA-3	129 ▶
Included Pullers						
10 Grip Puller		BHP-1762	BHP-252	BHP-352	BHP-552	145 ▶
20 Cross Bearing Puller		BHP-1772	BHP-262	BHP-362	BHP-562	146 ▶
30 Bearing Cup Puller		BHP-180	BHP-280	BHP-380	BHP-580	147 ▶
40 Bearing Separator		BHP-181	BHP-282	BHP-382	BHP-582	147 ▶
• Case		CM-6	CW-350	CW-350	CW-750	

* See warning on this page.

** Puller capacity at 540 bar; maximum cylinder capacity at 700 bar is 60 ton.

¹⁾ Includes Adaptor FZ-1630.

▼ Shown: Grip Puller Set BHP-351G



- Precise hydraulic control allows fast, efficient and safe pulling
- High quality, forged steel components provide superior reliability and service
- Available with and without full hydraulic set.

BHP Series



Capacity:

13, 22, 33 and 45 ton

Reach:

252 - 700 mm

Spread:

249 - 1100 mm

Maximum Operating Pressure:

700 bar

Ordering Example

Model Number BHP-251G:

includes Grip Puller BHP-252 and a full hydraulic set. (Hand pump, cylinder, saddle, hose, gauge and gauge adaptor).

Model Number BHP-252:

includes Grip Puller mechanical parts only, for use with your existing hydraulics.

▼ SELECTION CHART

Grip Puller Set Capacity **		13 ton	22 ton	33 ton	45 ton ***
Model Number ►		BHP-152 ¹⁾	BHP-251G	BHP-351G	BHP-551G
Included Hydraulics Set Weight ►		22 kg	56 kg	91 kg	160 kg
• Hand Pump		P-142	P-392	P-392	P-80
• Cylinder		RWH-121	RCH-202	RCH-302	RCH-603
• Saddle		-	HP-2015	HP-3015	HP-5016
• Hose		HB-7206QB	HC-7206	HC-7206	HC-7206
• Gauge		GF-120B	GF-813B	GF-813B	GF-813B
• Gauge Adaptor		GA-4	GA-3	GA-3	GA-3
10	Grip Puller Model Number ►	BHP-1762 *	BHP-252 *	BHP-352 *	BHP-552 *
Maximum Spread (mm)	2-jaw	249	400	593	899
	3-jaw	249	499	800	1100
Maximum Reach (mm)	2-jaw	252	300	387	700
	3-jaw	252	300	387	700
Jaw (mm)	Thickness	15	20	24	30
	Width	23	27	38	39
Adjusting Screw (mm)	Thread	¾" - 16 UNF	1" - 8 UNC	1¼" - 7 UNC	1½" - 5.5 UNS
	Length	400	670	790	975
• Case		CW-166	CW-166	CW-350	CW-750

¹⁾ Includes Adaptor FZ-1630.

* Grip Puller order number without hydraulics.

** See warning on page 144.

*** Puller capacity at 540 bar; maximum cylinder capacity at 700 bar is 60 ton.

BHP-Series, Cross Bearing Puller Sets

▼ Shown: Cross Bearing Puller Set BHP-361G



- Precise hydraulic control allows fast, efficient and safe pulling
- High quality, forged steel components provide superior reliability and service.

BHP Series



Capacity:

6, 11, 16 and 22 ton

Reach:

357 - 864 mm

Spread:

260 - 580 mm

Maximum Operating Pressure:

350 bar



The cross bearing puller without hydraulics, bearing cup puller and a bearing separator can be ordered separately, see items nr. 10, 20, 30 and 40.

▼ SELECTION CHART

Cross Bearing Puller Set Capacity		6 ton	11 ton	16 ton	22 ton	
	Model Number ▶	BHP-162 ¹⁾	BHP-261G	BHP-361G	BHP-561G	
	Set Weight ▶	26 kg	62 kg	121 kg	185 kg	
•	Hand Pump	P-142	P-392	P-392	P-80	
•	Cylinder	RWH-121	RCH-202	RCH-302	RCH-603	
•	Saddle	–	HP-2015	HP-3015	HP-5016	
•	Hose	HB-7206QB	HC-7206	HC-7206	HC-7206	
•	Gauge	GF-120B	GF-813B	GF-813B	GF-813B	
•	Gauge Adaptor	GA-4	GA-3	GA-3	GA-3	
20	Cross Bearing Puller ²⁾	Model Number ▶	BHP-1772	BHP-262	BHP-362	BHP-562
	Spread (mm)	Maximum	260	345	440	580
		Minimum	106	139	179	220
	Reach (mm)	Maximum	357	570	710	864
	Adjusting Screw (mm)	Diameter	3/4" - 16 UNF	1" - 8 UNC	1 1/4" - 7 UNC	1 5/8" - 5.5 UNS
		Length	400	675	795	975
	Leg (mm)	Length	105	239	203	609
		Length	357	419	457	863
		Length	–	571	711	–
		Length	–	114	–	–
	Upper Leg Ends (mm)	Thread	3/4" - 16 UNF	3/4" - 16 UNF	1-14 UNS	1 1/4" - 12 UNF
	Lower Leg Ends (mm)	Thread	5/8" - 18 UNF	5/8" - 18 UNF	1-14 UNS	1 1/4" - 12 UNF
30	Bearing Cup Puller ²⁾	Model Number ▶	BHP-180	BHP-280	BHP-380	BHP-580
40	Bearing Separator ²⁾	Model Number ▶	BHP-181	BHP-282	BHP-382	BHP-582
•	Wooden Case		CM-6	CW-187	CW-350	CW-750

¹⁾ Includes Adaptor FZ-1630.

²⁾ Can be ordered separately without hydraulic components, see next page.

Bearing Cup Pullers and Bearing Separators

▼ Shown: BHP-380



Bearing Cup Puller

- Made of high strength steel alloy
- Easily adapted to Cross Bearing Pullers for fast and efficient removal of the most difficult parts
- Adjustable to fit a variety of bearings and seals.

BHP Series



Capacity:

6, 11, 16 and 22 ton

Maximum Reach:

115 - 150 mm

Spread Range:

145 - 240 mm

Maximum Operating Pressure:

350 bar

▼ SELECTION CHART

Capacity *		6 ton	11 ton	16 ton	22 ton
30 Bearing Cup Puller					
Model Number ▶		BHP-180	BHP-280	BHP-380	BHP-580
Spread (mm)	Max.	110	220	359	359
	Min.	26	25	50	50
Reach (mm)	Max.	110	140	145	145
Center Screw	Thread	3/4" - 16 UNF	1" - 8 UNC	1 1/4" - 7 UNC	1 5/8" - 5.5 UNS

* Puller capacity, not attachment capacity. See warning on this page.



WARNING

Do not exceed 50% of the rated puller capacity when using a double crosshead (2 grip arms) or when using puller legs in combination with bearing puller attachments.

▼ Shown: BHP-382



Bearing Separator

- Made of high strength steel alloy
- Wedge-shaped edges allow removal of the most hard-to-grip components
- Easily adapted to Cross Bearing Pullers for fast and efficient removal of the most difficult parts.

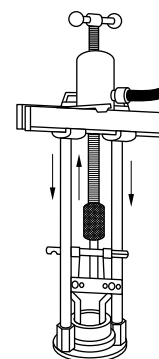

◀ Bearing Cup Puller shown with Crosshead Puller Attachment.

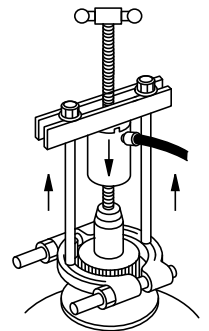

Bearing Separator shown with Crosshead Puller Attachment. ▶

▼ SELECTION CHART

Capacity *		6 ton	11 ton	16 ton	22 ton
40 Bearing Puller					
Model Number ▶		BHP-181	BHP-282	BHP-382	BHP-582
Spread (mm)	Max.	104	130	245	245
	Min.	25	9	17	17
Width (mm)		126	150	292	292
Thread		5/8" - 18 UNF	3/4" - 18 UNF	1" - 14 UNS	1 1/4" - 12 UNF

* Bearing Separator rated at 50% of puller capacity. See warning on this page.



Bearing Separator

Bearing Separator has wedge shaped edges for placing puller behind hard to reach bearings, gears, etc., where clearance prevents direct application of grip puller arms.

The Bearing Separator can be used with the Cross Bearing Puller or the Grip Puller.

▼ Shown from left to right: EP-206, EP-108



- Patented 'Safety Cage' jaw retention system
- Roll threaded shafts for less effort when applying high torque
- Slim tapered jaws for improved gripping in tight spots
- Available in 2 and 3 jaw design and inside and outside pulling configuration
- More efficient pulling, as one man can do the job where manual pullers often require two operators.



For Safer and Faster Pulling



Long Jaws

Long Jaws are used to increase the reach and spread of manual pullers. They maintain the same pulling capacity as the standard jaws, but reduce clamping force by 25%.

Page: 151



Shaft Attachments

Shaft protectors and extenders are live centers that fit over the standard puller shaft for tip protection and additional reach.

Page: 151



Application Tip

Because of the unique safety cage design, Posi Lock® pullers will grip on surfaces where normal pullers would slip off; e.g. tapered bearings.

◀ Positioning an EP-104, 3-jaw puller on the drive pulley of an electric motor.

Posi Lock® Mechanical Grip Pullers

External Posi Lock® Pullers

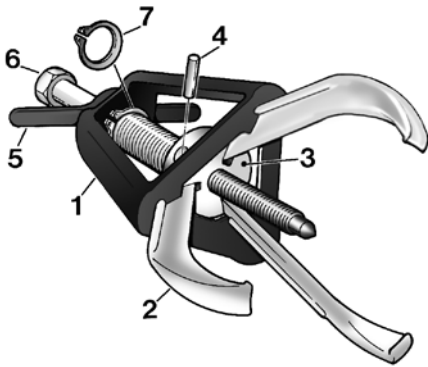

- 1 Patented 'Safety Cage' guides jaws, holding them securely onto the part.
- 2 Durable forged jaws provide positive grip.
- 3 Jaw head provides pivot and reaction point for jaws.
- 4 Pin, for easy jaw removal and replacement.
- 5 T-handle provides control of the puller jaws.
- 6 Drive bolt with rolled threads for increased force with reduced input torque.
- 7 Snap-ring retains cage to drive bolt and provides quick removal for easy service.

EP EPP Series



Capacity:

2 - 40 ton

Maximum Reach:

101 - 355 mm

Spread Range:

12 - 635 mm

▼ QUICK SELECTION CHART EXTERNAL PULLERS

For quick technical information see next page.

Number of Jaws	Maximum Reach	Spread (min. - max.)	Capacity	Model Number	Center Bolt Diameter	 (kg)
	(mm)					
2	101	12 - 127	2 (17)	EP-204	14	1,4
3	101	12 - 127	5 (45)	EP-104	14	1,8
2	152	12 - 178	6 (53)	EP-206	16	3,2
3	152	12 - 178	10 (89)	EP-106	16	3,6
2	203	19 - 304	12 (106)	EP-208	20	5,4
3	203	19 - 304	17 (151)	EP-108	20	6,4
2	245	25 - 381	14 (124)	EP-210	20	5,9
3	245	25 - 381	20 (178)	EP-110	20	7,3
2	304	63 - 457	25 (222)	EP-213	29	17,2
3	304	63 - 457	30 (267)	EP-113	29	20,0
2	355	76 - 635	35 (311)	EP-216	31	25,8
3	355	76 - 635	40 (356)	EP-116	31	30,8



IMPORTANT!

Always wear Safety Goggles and Gloves while using pullers.

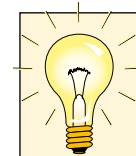

Application Tip

In determining the correct manual puller capacity for your application, use the following rule:

The center bolt diameter of the puller should be at least ½ the diameter of the shaft being pulled on.

Example:

A part being pulled from a shaft with a diameter of 38 mm would require a puller with a center bolt diameter of at least 19 mm.

Internal Posi Lock® Puller

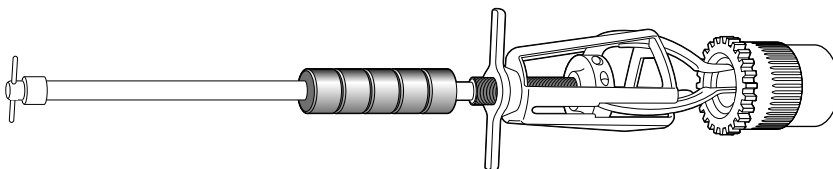

▼ QUICK SELECTION CHART INTERNAL PULLERS

Number of Jaws	Maximum Reach	Spread (min. - max.)	Jaw Style	Model Number	Jaw Length	 (kg)
	(mm)				(mm)	
3	168	14 - 101	Standard *	EPPMI-6	168	3,9
	218	25 - 133	Long *		218	3,9

* Both Standard and Long Jaws are included with EPPMI-6.

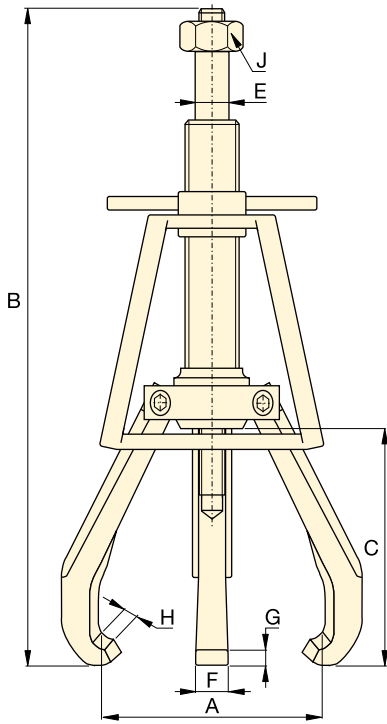

**2 and 3 Jaw External Puller
EP-Series**

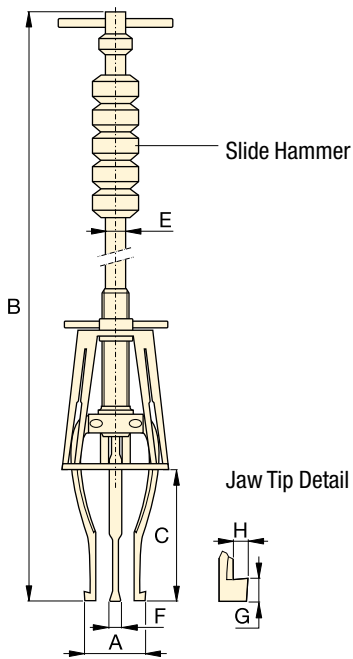

**Internal Puller
EPPMI-6**



▲ EP-204 2 jaw puller positioned to pull a water pump drive pulley.

▼ **QUICK SELECTION CHART EXTERNAL PULLERS**

Number of Jaws	Maximum Reach (mm)	Spread min. - max. (mm)	Capacity ton (kN)	Model Number	Center Bolt Diameter (mm)	Maximum Torque (Nm)
2	101	12 - 127	2 (17)	EP-204	14	27
3	101	12 - 127	5 (45)	EP-104	14	54
2	152	12 - 178	6 (53)	EP-206	16	102
3	152	12 - 178	10 (89)	EP-106	16	176
2	203	19 - 304	12 (106)	EP-208	20	203
3	203	19 - 304	17 (151)	EP-108	20	298
2	245	25 - 381	14 (124)	EP-210	20	237
3	245	25 - 381	20 (178)	EP-110	20	373
2	304	63 - 457	25 (222)	EP-213	29	644
3	304	63 - 457	30 (267)	EP-113	29	814
2	355	76 - 635	35 (311)	EP-216	31	1085
3	355	76 - 635	40 (356)	EP-116	31	1153

▼ **QUICK SELECTION CHART INTERNAL PULLERS**

Number of Jaws	Maximum Reach (mm)	Spread min. - max. (mm)	Jaw Style	Model Number	Jaw Length (mm)	Slide-hammer weight (kg)
3	168	14 - 101	Standard *	EPPMI-6	168	1,1
	218	25 - 133	Long *		218	1,1

* Both Standard and Long Jaws are included with EPPMI-6.

Posi Lock® Mechanical Pullers



Shaft Attachments

Shaft protectors and extenders are live centers that fit over the standard puller shaft for tip protection and additional reach.



Long Jaws

Long Jaws are used to increase the reach and spread of pullers. They maintain the same pulling capacity as the standard jaws, but reduce clamping force by 25%.

EP EPP Series



Capacity:

2 - 40 ton

Maximum Reach:

101 - 355 mm

Spread Range:

12 - 635 mm



▼ SHAFT ATTACHMENTS

Length (mm)	Dia- meter (mm)	Increases Center Bolt Length (mm)	Model Number
25	19	9	EPP-4
50	19	38	EPX-4
31	22	12	EPP-6
50	22	38	EPX-6
31	25	12	EPP-10
50	25	38	EPX-10
50	35	21	EPP-1316

▼ LONG JAWS

Spread min. - max. (mm)	Max. Reach (mm)	Model Number
57 - 381	245	EP-11054
38 - 558	400	EP-11054L
38 - 762	508	EP-11354L
25 - 133	218	EP-10554L*

* for EPPMI-6 only

Dimensions (mm)									Model Number	Optional Accessories		
Spread min. - max. A	Overall Length B	Max. Reach C	Center Bolt Diam. E	Jaw Width F	Tip Clearance G	Tip Depth H	Hex Socket Size (inch) J					
12 - 127	245 - 323	101	14	15	4,1	4,6	7/8	EP-204	EPP-4	EPX-4	-	
12 - 127	245 - 323	101	14	15	4,1	4,6	7/8	EP-104	EPP-4	EPX-4	-	
12 - 178	323 - 476	152	16	19	8,1	6,1	1 1/16	EP-206	EPP-6	EPX-6	-	
12 - 178	323 - 476	152	16	19	8,1	6,1	1 1/16	EP-106	EPP-6	EPX-6	-	
19 - 304	412 - 615	203	20	22	6,4	9,1	1 1/4	EP-208	EPP-10	EPX-10	EP-11054	
19 - 304	412 - 615	203	20	22	6,4	9,1	1 1/4	EP-108	EPP-10	EPX-10	EP-11054	
25 - 381	489 - 736	245	20	25	6,4	9,1	1 1/4	EP-210	EPP-10	EPX-10	EP-11054L	
25 - 381	489 - 736	245	20	25	6,4	9,1	1 1/4	EP-110	EPP-10	EPX-10	EP-11054L	
63 - 457	660 - 965	304	29	31	12,7	9,7	1 11/16	EP-213	EPP-1316	-	EP-11354L	
63 - 457	660 - 965	304	29	31	12,7	9,7	1 11/16	EP-113	EPP-1316	-	EP-11354L	
76 - 635	800 - 1155	355	31	36	13,5	11,7	1 13/16	EP-216	EPP-1316	-	-	
76 - 635	800 - 1155	355	31	36	13,5	11,7	1 13/16	EP-116	EPP-1316	-	-	

Note: Overall length (B) is dependent on position of center bolt.

Dimensions (mm)							Model Number
Spread min. - max. A	Overall Length B	Max. Reach C	Slide Rod Dia. E	Jaw Width F	Tip Clearance G	Tip Depth H	
14 - 101	736	168	14,2	8	3,0	1,5	EPPMI-6
25 - 133	787	218	14,2	8	7,6	4,6	



Always wear Safety Goggles and Gloves while using pullers.

▼ Shown: EPHR-110



- Patented 'Safety Cage' jaw retention system
- High force hydraulic system for effortless pulling of large components
- Slim tapered jaws for better gripping in tight spots
- Available in 2 and 3 jaw design
- More efficient pulling, as one man can do the job where manual pullers often require two operators.

▼ An EPH-113 hydraulic Posi Lock® puller easily removes machined parts from a heavy-production press.



High-Tech Pulling



Transport and Store

Conveniently stores and transports hydraulic pullers and accessories. Order the **EPT-2550** Storage Cart and make your job easier to do!



Long Jaws

Used to increase the reach and spread of pullers. They maintain the same pulling capacity as the standard jaws, but reduce clamping force by 25%.

Page: **154**



Application Tip

Because of the unique safety cage design, Posi Lock® pullers will grip on surfaces where normal pullers would slip off; e.g. tapered bearings.

▼ SELECTION CHART

Number of Jaws	Maximum Spread	Capacity	Model Number *
	(mm)		
2	304	10 (101)	EPH-208
3	304		EPH-108
2	381	15 (142)	EPH-210
3	381		EPH-110
2	457	25 (232)	EPH-213
3	457		EPH-113
2	635	50 (498)	EPH-216
3	635		EPH-116

* Cylinder is not included.

Posi Lock® Hydraulic Grip Pullers

▼ SETS SELECTION CHART

Style	Capacity (ton)	Basic Puller	Cylinder	Stroke (mm)	Pump Set	Set Model Number **	 (kg)
2 Jaw Puller	10	EPH-208	RC-106	152	-	EPHR208	10
	10	EPH-208	RC-106	152	EP-1E	EPHS208E	27
	15	EPH-210	RC-1510	254	-	EPHR210	22
	15	EPH-210	RC-1510	254	EP-1E	EPHS210E	38
	25	EPH-213	RC-2514	362	-	EPHR213	44
	25	EPH-213	RC-2514	362	EP-1E	EPHS213E	53
	50	EPH-216	RC-5013	336	-	EPHR216	87
3 Jaw Puller	10	EPH-108	RC-106	152	-	EPHR108	11
	10	EPH-108	RC-106	152	EP-1E	EPHS108E	28
	15	EPH-110	RC-1510	254	-	EPHR110	23
	15	EPH-110	RC-1510	254	EP-1E	EPHS110E	39
	25	EPH-113	RC-2514	362	-	EPHR113	48
	25	EPH-113	RC-2514	362	EP-1E	EPHS113E	57
	50	EPH-116	RC-5013	336	-	EPHR116	91
	50	EPH-116	RC-5013	336	EP-2E	EPHS116E	127

** Standard set EPHS models shipped with 230 VAC pump.

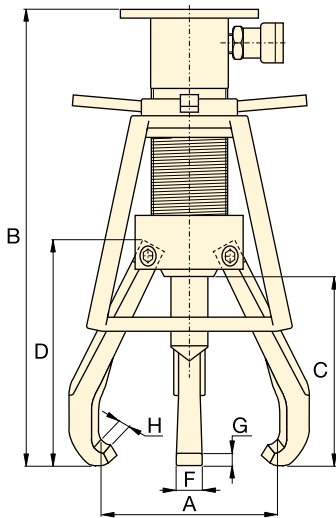

EPH Series



Capacity:

10 - 50 ton

Maximum Reach:

203 - 355 mm

Spread Range:

19 - 635 mm

Maximum Operating Pressure:

700 bar

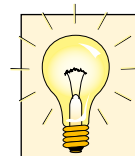





Pump Sets

All Posi Lock® Hydraulic Puller Sets that include 230 VAC pumps, will feature the following components:



	EP-1E Pump Set	EP-2E Pump Set
Pump	PUJ-1200E	ZE4210ME
Hose	HC-7210	HC-7210
Gauge	G-2535L	G-2535L
Adaptor	GA-3	GA-3

Components for 115 VAC pumps are available on request.

Dimensions (mm)							 (kg)	Model Number *	Accessories ¹⁾		
Spread min. - max.	Overall Length	Maximum Reach	Jaw Length	Jaw Width	Tip Clearance	Tip Depth			Standard included	Standard included	Optional
A	B	C	D	F	G	H					
19 - 304	498	203	237	22	7,4	6,9	6,4	EPH-208	EPH-155	EPH-11052	EP-11054
19 - 304	498	203	237	22	7,4	6,9	7,3	EPH-108	EPH-155	EPH-11052	EP-11054
25 - 381	665	245	270	25	11,2	9,1	10,0	EPH-210	EPH-155	EPH-11052	EPH-11054L
25 - 381	665	245	270	25	11,2	9,1	11,3	EPH-110	EPH-155	EPH-11052	EPH-11054L
63 - 457	846	304	348	31	12,9	9,7	21,3	EPH-213	EPH-257	EPH-11352	EPH-11354L
63 - 457	846	304	348	31	12,9	9,7	25,0	EPH-113	EPH-257	EPH-11352	EPH-11354L
76 - 635	919	355	413	36	15,0	11,7	40,8	EPH-216	EPH-508	EPH-11652	-
76 - 635	919	355	413	36	15,0	11,7	45,4	EPH-116	EPH-508	EPH-11652	-

¹⁾ See next page for details.

▼ RAM POINT SETS SELECTION CHART

Fits Puller Set Model Number	EPH-208, EPH-210 EPH-108, EPH-110	EPH-213 EPH-113	EPH-216 EPH-116
			
Ram Point Set ¹⁾ Model Number	EPH-155	EPH-257	EPH-508
Ram Points Included:	Ram Point Dimensions Diameter x Length (mm)		
Flat Ram Points	ø25 x 25	ø38 x 57	ø51 x 76
	ø25 x 76	ø51 x 57	ø70 x 76
Tapered Ram Points	–	ø51 x 102	ø70 x 127
	ø25 x 38	ø38 x 64	ø51 x 95
	ø25 x 89	ø51 x 64	ø51 x 95
Ram Point Adaptor	–	–	ø70 x 57

¹⁾ Standard included in EPH-Series Posi Lock Pullers.

EPH Series



Capacity:

10 - 50 ton

Maximum Reach:

246 - 508 mm

Spread Range:

57 - 762 mm



IMPORTANT!



Always wear Safety Goggles and Gloves while using pullers.

▼ LIFT PLATE SELECTION CHART

Fits Puller Set Model Number	Model Number *	Thick-ness (mm)	Dia-meter (mm)	
EPH-208	EPH-11052	6,4	ø153	
EPH-108	EPH-11052	6,4	ø153	
EPH-210	EPH-11052	6,4	ø153	
EPH-110	EPH-11052	6,4	ø153	
EPH-213	EPH-11352	9,7	ø203	
EPH-113	EPH-11352	9,7	ø203	
EPH-216	EPH-11652	9,7	ø254	
EPH-116	EPH-11652	9,7	ø254	

* Mounting screws included. Lifting plates are standard included with EPH-Series Pullers.

▼ LONG JAW SELECTION CHART

Fits Puller Set Model Number	Model Number	Number of Jaws required	Spread (mm)	Reach (mm)	 (kg)		Long Jaws are optional accessories and used for added reach and spread. They have the same load capacity as standard jaws with 25% of the clamping force.
EPH-208	EP-11054	2	57 - 381	246	1,1		
EPH-108	EP-11054	3	57 - 381	246	1,1		
EPH-210	EPH-11054L	2	38 - 559	401	2,5		
EPH-110	EPH-11054L	3	38 - 559	401	2,5		
EPH-213	EPH-11354L	2	38 - 762	508	4,8		
EPH-113	EPH-11354L	3	38 - 762	508	4,8		

Posi Lock® 100 Ton Hydraulic Grip Pullers

▼ EPH-1003E



- Roller cart with power lift
- Hydraulically actuated lift cylinder on cart extends puller from ground to a height of 1,69 m
- Adjustable jaw tips
- Includes ZE3-Series 230 Volt electric one stage pump with remote pendant for fingertip control of the removal process

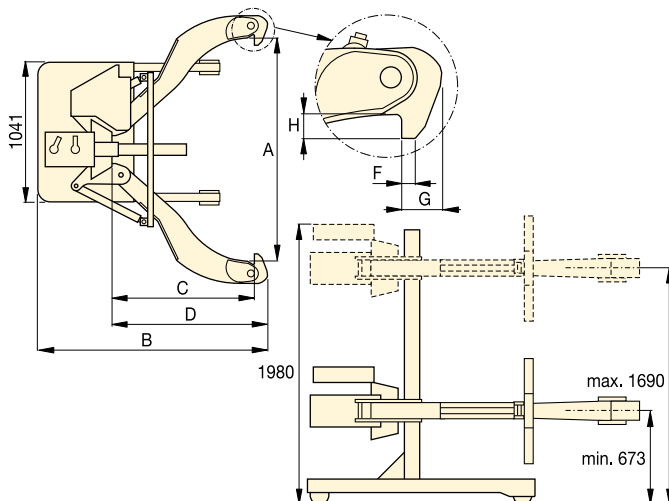

EPH Series



Capacity:
100 ton

Maximum Reach:
1219 mm

Spread Range:
190 - 1778 mm

Maximum Operating Pressure:
700 bar

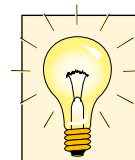

Pushing Adaptors

All Posi Lock® 100 Ton Hydraulic Pullers include following pushing adaptors.

Diameter (mm)	Length (mm)	Model Number
89	737	EPHT-1162
89	483	EPHT-1163
89	229	EPHT-1164

▼ The EPH-1002E quickly and easily removes this drive coupler from its shaft.



Number of Jaws	Spread Range A (mm)	Capacity ton (kN)	Model Number	Cylinder Stroke (mm)	Overall Length B (mm)	Reach C (mm)	Jaw Length D (mm)	Jaw Width F (mm)	Tip Clearance G (mm)	Tip Depth H (mm)	Weight (kg)
2	190 - 1778	100 (980)	EPH-1002E	250	1955	1219	1346	32	89	89	771
3	190 - 1778	100 (980)	EPH-1003E	250	1955	1219	1346	32	89	89	907